



Operating Instructions and Owner's Manual

LF1.5WP and LF1.5WP-CA

PLEASE READ THIS MANUAL CAREFULLY BEFORE OPERATING YOUR NEW
LIFAN Power USA Water Pump
(-CA) Indicates this unit is CARB Certified for California



PLEASE READ THE **FOLLOWING INSTRUCTIONS!**

1. Unit Shipped with “NO OIL” in Engine or where applicable pumps and/or accessories. Check and fill with proper oil as outlined in the Owner’s Manual for the respective product.
2. For repair under Warranty or questions concerning Warranty, DO NOT return this product to the Store where purchased. Follow the procedures as outlined in the “WARRANTY POLICY” and “WARRANTY REGISTRATION” in the Owner’s Manual. For any questions visit www.lifanpowerusa.com or call 1-866-471-7464.
3. Read the “Owner’s Manual” prior to operating any equipment and familiarize yourself with the proper and safe operation of the equipment. If you have any questions, visit www.lifanpowerusa.com or call 1-866-471-7464.

This Owner’s Manual is for the Following Models:



LF1.5WP

LF1.5WP-CA

(LF) indicates this unit is a LIFAN product.

(WP) indicates this unit is a Water Pump

(-CA) indicates this unit is CARB Certified for California

2

LIFAN Power USA
2205 Industrial Park Road
Van Buren, AR 72956
866-471-7464
www.lifanpowerusa.com

TABLE OF CONTENTS

Preface	4
Product Specifications	5
Safety Instructions	6
PRE-OPERATING INSTRUCTIONS	9
Connecting Water Inlet Hose	9
Connecting Water Outlet Hose	10
Engine Oil Level Check	11
Engine Fuel Level Check	12
Air Cleaner Element Check	13
Pump Water Capacity Check	14
Operation of Water Pump	15
Transporting and Storing the Unit	18
Maintenance	20
Troubleshooting	24
Water Pump Safety	25
Limited Warranty Policy	26

Preface

Thank you for choosing LIFAN Power USA for your Power Equipment Needs. LIFAN Power USA prides itself on providing quality products at affordable pricing, creating the “Best Equipment Value on Today’s Market!”

All LIFAN Power USA products are manufactured utilizing the latest technology. Built with quality components, your new Power Equipment Product will give you years of dependable service. Your unit, along with all of LIFAN Power USA products are designed, engineered, and manufactured with LIFAN’s Industrial Grade Gasoline Engine.

This Owner’s Manual will provide you with all of your needed information for your new Power Equipment Product, including Safe Operation and Maintenance of your unit. Please read this Owner’s Manual completely and carefully prior to operation. Keep this Owner’s Manual for assistance in the future, such as proper maintenance schedules and tips to prolong the life and effective use of your unit. If you require assistance, please visit our website (www.lifanpowerusa.com) or call toll free 866-471-7464.

This Owner’s Manual contains information with respect to the newest products at the time of publication. Due to revision and modifications, the information noted in the Owner’s Manual might vary from the actual status. This Owner’s Manual is subject to change without notice. The copyright of the Owner’s Manual belongs to EquipSource, LLC. Any group or individual is forbidden to reprint or copy any of this Owner’s Manual without the written consent of EquipSource, LLC.

FOR ALL WARRANTY AND SERVICE RELATED ISSUES/QUESTIONS DO NOT RETURN YOUR UNIT TO THE STORE OR DEALER WHERE THE ITEM WAS PURCHASED. FOR SERVICE VISIT LIFAN POWER USA’S WEBSITE (WWW.LIFANPOWERUSA.COM) OR CALL 1-866-471-7464. WE WILL BE HAPPY TO HANDLE YOUR WARRANTY ISSUE OR DIRECT YOU TO THE NEAREST “AUTHORIZED SERVICE CENTER.”



LIFAN Power USA



PRODUCT SPECIFICATIONS

Pro Series Water Pump

Model	LF1.5WP(-CA)
Suction/Discharge Diameter	1.5 in
Rotation Velocity	4200rpm
Delivery	2377 gph
Suction Lift	13.12 ft
Maximum Pump Head	49.21 ft

ENGINE

Manufacturer	LIFAN
Model	LF152F-3BP
Type	4-Stroke OHV Single Cylinder
Maximum Horsepower (MHP)^a	2.5MHP
Displacement	97.7cc
Starting System	Recoil
Fuel Tank Capacity	0.37 Gallon
Run Time	2.5 hrs
Fuel Type	87 Octane Gasoline
Oil Type & Amount	SAE 10w30w 12 oz
Low Oil Shutoff Protection	Yes
CARB Certified	(-CA) Models Only

Dimensions

Length	15in (38.1cm)
Width	12in (30.48cm)
Height	12in (30.48cm)
Dry Weight	22.5 lbs (10.2hg)

Comments

MHP^a = Maximum Horsepower gph = gallons per hour
L/hr = Liters per hour

Lifan Power USA
2205 Industrial Park Road
Van Buren, AR 72956
866 741-7464



For Additional Lifan Product Information,
Scan the QR Code to the Left, Or Visit
www.lifanpowerusa.com

LIFAN Power USA
2205 Industrial Park Road
Van Buren, AR 72956
866-471-7464
www.lifanpowerusa.com

Safety Instructions



This is the safety alert symbol. It is used to alert you to potential personal injury hazards. Obey all safety messages that follow this symbol to avoid possible injury or death.

For your safety read this manual carefully. Become familiar with the proper operation, care, and maintenance of your LIFAN Power USA water pump.

The safety and alert symbol () is used with a signal word (**CAUTION**, **DANGER**, **WARNING**), a pictorial and/or safety message to alert you to hazards. **CAUTION** indicates a hazard that, if not avoided, could result in minor or moderate injury. **DANGER** indicates a hazard that, if not avoided, could result in death or serious injury. **WARNING** indicates a hazard that, if not avoided, could result in death or serious injury.

Hazard Symbols and Meanings

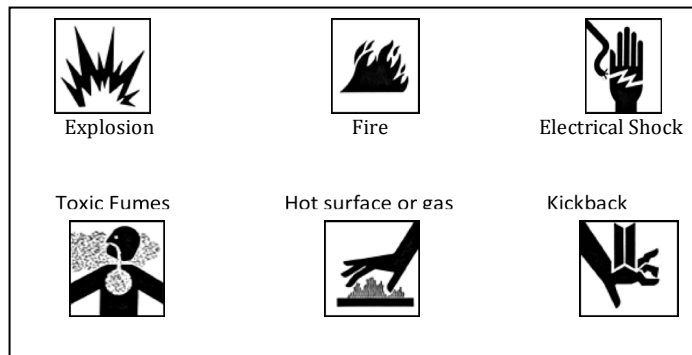

WARNING!

Running water pump emits carbon monoxide: an odorless, colorless, poison gas.
Breathing carbon monoxide can cause nausea or death!

ONLY operate water pump outdoors.

Exhaust gas must be prevented from entering confined areas.

Direct exhaust gas away from windows, doors, ventilation and other openings.



Do not operate water pump inside or under any buildings.





WARNING!







The engine exhaust from this water pump contains chemicals known to the state of California to cause birth defects, reproductive harm, and cancer.

Safety Instructions (continued)

	WARNING!
	Rapid recoil of starter cord (kickback) may pull hand and arm forward toward engine at a rapid rate. Broken bones, bruises, sprains, and fractures may result.
<ul style="list-style-type: none"> • When starting engine, pull cord slowly until tension is felt, then pull rapidly to avoid kickback. 	

	WARNING!
	Fuel and its vapors are extremely flammable and explosive.
	Fire or explosion can cause severe burns or death.
<p>WHEN ADDING OR DRAINING FUEL</p> <ul style="list-style-type: none"> • Turn water pump off and let it cool for at least three minutes before removing fuel cap. Loosen cap slowly in order to relieve pressure in the fuel tank. • Fill or drain fuel tank outdoors. Do not excessively inhale fuel vapors. • Keep away from open flames or sparks and other sources of ignition. • Do NOT smoke while filling fuel tank. • Do NOT overfill tank. Allow space for fuel expansion. <p>WHEN TRANSPORTING OR REPAIRING EQUIPMENT</p> <ul style="list-style-type: none"> • Transport water pump with the fuel valve in the off position. • Repair water pump with the fuel tank empty or the fuel valve in the off position. • Disconnect spark plug wire before transport or service. <p>WHEN STORING FUEL OR EQUIPMENT CONTAINING FUEL</p> <ul style="list-style-type: none"> • Store away from furnaces, stoves, water heaters, clothes dryers or other appliances that have pilot light or other ignition source because they can ignite fuel vapors. <p>WHEN STARTING EQUIPMENT</p> <ul style="list-style-type: none"> • Ensure spark plug, muffler, air cleaner, and fuel cap are in place. • Do NOT crank engine with spark plug removed. • If fuels spills, wait until it evaporates before starting engine. <p>WHEN OPERATING EQUIPMENT</p> <ul style="list-style-type: none"> • Do not choke carburetor to stop engine. • Do not tip engine or equipment at an angle, which causes fuel to spill. 	

Safety Instructions (continued)

		WARNING!
	While engine is running temperature may exceed 150°F (65°C). Server burns may occur.	
	Exhaust heat/gasses can ignite combustibles, structures or damage fuel tank causing a fire.	
<ul style="list-style-type: none">• Do NOT touch hot surfaces and do avoid exhaust gasses.• Allow water pump to cool before touching.• Keep at least 6 ft. (183cm) clearance on all sides of water pump including overhead clear.• Reflective exhaust heat may damage fuel tank causing fire.• Code of Federal Regulation(CFR) Title 36 Parks, Forests, and Public Property require equipment powered by an internal combustion engine to have a spark arrester, maintained in working order, complying to USDA Forest service standard 5100-1c or later revision. In the state of California a spark arrester is required under section 4442 of the California Public resources code.		
		WARNING!
	Unintentional sparking can result in fire or electrical shock.	
		
WHEN TESTING FOR ENGINE SPARK <ul style="list-style-type: none">• Do NOT check for spark with the spark plug removed.• Use approved spark plug tester.		
WHEN REPAIRING OR ADJUSTING WATER PUMP <ul style="list-style-type: none">• Disconnect the spark plug wire from the spark plug and place the wire where it cannot contact spark plug.		

CAUTION!	
Improper use and care of this water pump will cause damage and shorten its lifespan. Failure to follow these actions will void all warranties.	
<ul style="list-style-type: none">• Use water pump only for appropriate and designated purposes.• The dealer or customer helpline (1-866-471-7464) can instruct you on intended uses.• Water pump must be placed on a level surface.• Do NOT expose water pump to extreme conditions. Excessive dust, moisture, and corrosive vapors will damage unit.• Cooling slots must be kept clear of debris.• Shut off water pump and take to a qualified service center if the water pump fails to operate properly.	

NOTE: Pumping of inflammable or corrosive liquids, such as gasoline, seawater, chemical solutions, alkaline liquids, or acids, is forbidden with this unit!

Pre-Operating Instructions: Connecting Water Inlet Hose

Use commercially available hose, hose joint, and clamp. The water inlet hose must be of continuous structure and be rigid. The length of the hose should be no more than required. The effect of suction is greatest at shorter distances from the water surface. Suction time varies with the length of the water inlet hose. The filter matching with the water pump should be mounted to the end of the water inlet hose with a hose clamp, as shown in the diagram below.

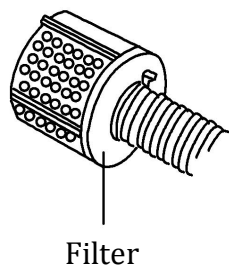

Water Inlet Hose

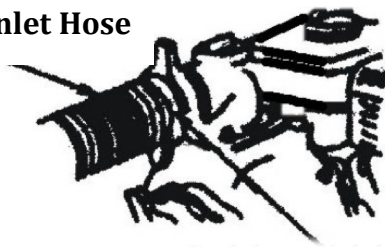

Hose clamp



CAUTION:

- Before pumping, install the filter securely to the end of the water inlet hose. This filter will filtrate any impurity, which may produce a passage jam and damage impellers.
- Be sure to install the hose joint and clamp properly to prevent air leaks and pumping performance drop; a loose water inlet hose will decrease the water pump performance and self-suction ability.

Pre-Operating Instructions: Connecting Water Outlet Hose

Use commercially available hose, hose joint, and clamp. A short hose with a big diameter will provide the best performance. A long hose with a small diameter will increase flowing resistance and decrease the power output of the water pump. See diagram below.

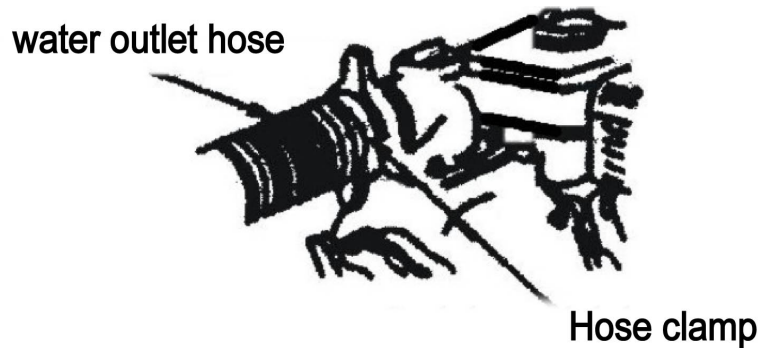

NOTE: Tighten the hose clamp to keep from disengaging during operation under high pressure.

Pre-Operating Instructions: Engine Oil Level Check



CAUTION:

- Running engine with insufficient engine oil can cause severe damage to the engine.
- The engine performance and service life is directly dependent of the quality of the engine oil. Do NOT use contaminated engine oil or vegetable oil.
- Check engine oil level only with engine stalled and with unit on level ground.
 - Use 4-Stroke Gasoline Engine Oil equivalent in quality with SF, SG from API.

Oil viscosity varies with average environmental temperature. Select engine oil with proper viscosity using the chart to the right in accordance with your regional environmental temperature.

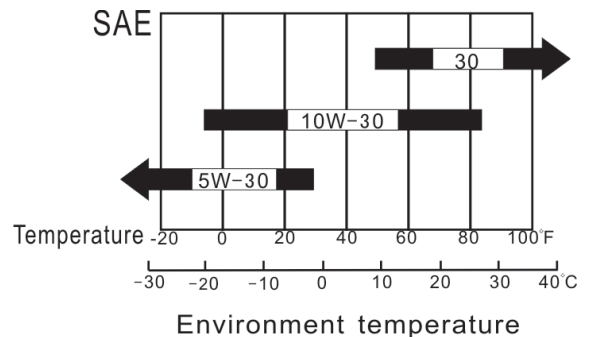

Engine Oil Alarm System

The engine oil alarm system aids in avoiding engine damage due improper amounts of engine oil in the crankcase. Before the engine oil level in the crankcase drops below the safety line, the engine oil alarm system will automatically stall the engine (while the engine switch remains in the "ON" position).

If the engine stops and will not restart:

1. Remove the engine oil dipstick and wipe it clean.
2. Insert the dipstick into engine oil filler hole without screwing it in
3. Remove dipstick and check engine oil amount.
4. If engine oil is below required amount, fill specified engine oil up to the top of filler hole. Use engine oil depended on environmental temperature. Refer to Product Specification section for proper engine oil capacity. Reinstall oil dipstick.

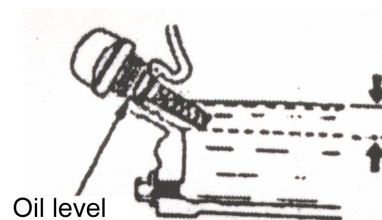
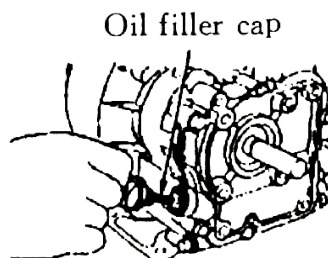

Pre-Operating Instructions: Engine Fuel Level Check



CAUTION:

- Gasoline is extremely flammable. Keep away from ignition sources.
- Fuel unit only in well-ventilated areas with the engine stalled.
- Do NOT smoke near unit.
- Do NOT spill fuel out of the fuel tank. Spilled gasoline and gasoline vapor may ignite. If gasoline is spilled, wipe completely dry before starting the engine.
- Avoid repeated or sustained breathing of gasoline fumes.
- Avoid skin contact with gasoline.
- Keep out of reach of children and pets.
- Do NOT use contaminated gasoline. Keep dirt, dust, and water out of fuel tank.
- After fueling is complete, ensure fuel filler cap is securely fastened.

To Check Engine Fuel Level:

1. Remove fuel filler cap.
2. Visually check fuel level within gas tank.
3. If too low, add fuel. Only use specified gasoline; Unleaded Gasoline is recommended. Refer to Product Specification section for fuel tank capacity.
4. Reinstall fuel filler cap

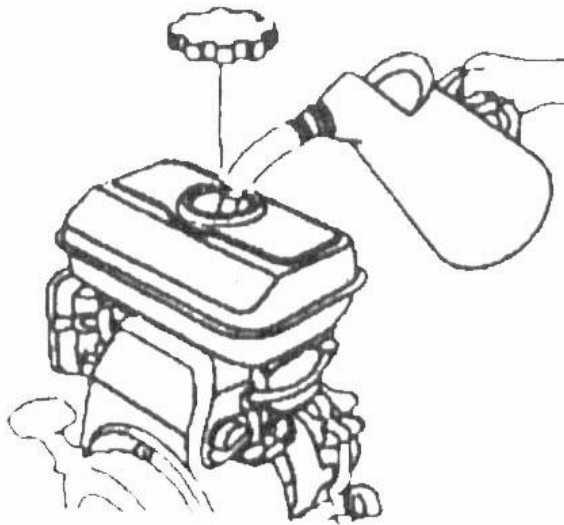

Fig. 4

12

LIFAN Power USA
2205 Industrial Park Road
Van Buren, AR 72956
866-471-7464
www.lifanpowerusa.com

Pre-Operating Instructions: Air Cleaner Element Check



CAUTION:

- Do NOT run the engine without air cleaner element installed. Operation of engine without air cleaner element installed will result in the inhalation of dirt, dust, and other debris into the engine and through the carburetor. This will result in premature wear of the engine.

To Check Air Cleaner Element:

1. Remove the clip (item 9 in "Air Cleaner A" below) or the wing nut (item 7 in "Air Cleaner B" below) to remove and check the air filter element.
2. For Sponge Type Air Filters, wash with soap and water when contaminated. Squeeze excess liquid from air filter element, and allow the air filter element to dry.
For Paper Type Air Filters, replace with the correct Air Filter for your unit. They are available at your dealer or from LIFAN Power USA. Order your filter by calling toll free 866-471-7464.
3. Re-Install the air filter element into the air filter housing.

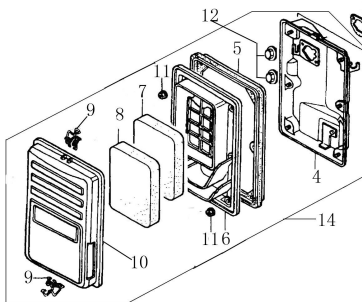

Air Cleaner A

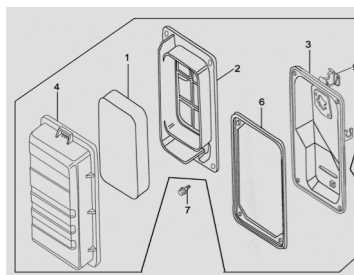

Air Cleaner B

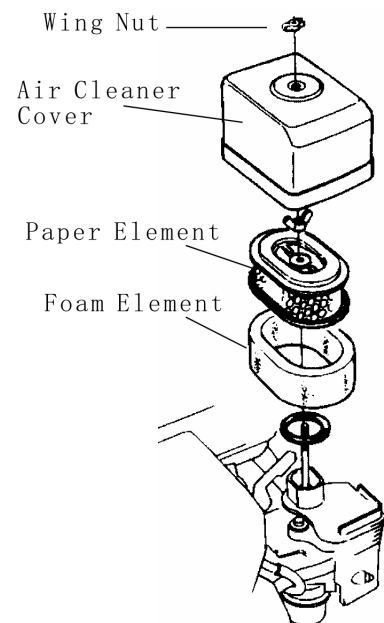

Pre-Operating Instructions: Pump Water Capacity Check



CAUTION:

- Do NOT run engine without water inside the pump. Operation of engine without water inside the pump will cause the pump to overheat. Prolonged operation of engine without water inside the pump will damage the pump gasket and impeller.
- If water within the pump is not full, shut off the engine at once and fill the pump after allowing the unit to cool.

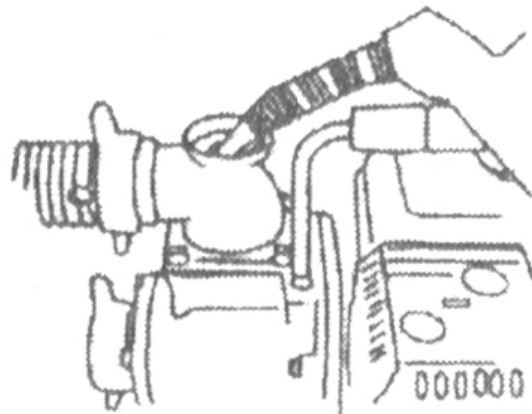
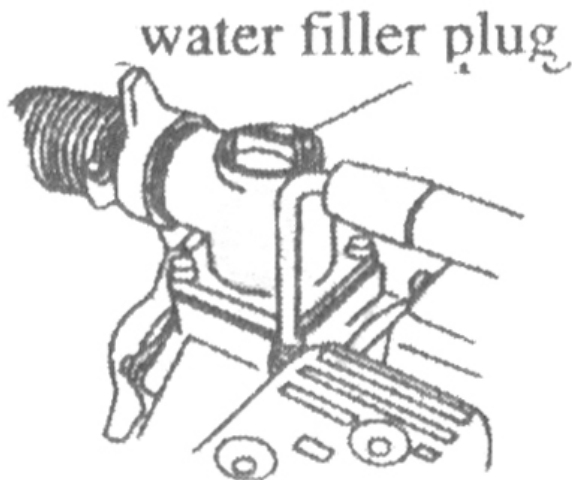

To Check Pump Water:

1. Remove Water Filler Cap.
2. Visually Check for Water inside pump.
3. If too low, add water through Water Filler Hole.
4. Securely re-fasten Water Filler Cap.



Operation of Water Pump

Water Pump Use Location:

	WARNING!
	Running water pump gives off carbon monoxide gas. It is odorless, colorless, and highly toxic. Breathing carbon monoxide gas can lead to fainting, nausea or may result in death.
<ul style="list-style-type: none">• Only operate water pump outdoors.• Prevent exhaust gas from entering, through windows doors or ventilation intakes, any confined areas.• DO NOT operate water pump inside any enclosed or roofed areas.	

Before Operating Water Pump:

1. Check water pump condition.
 - a. Inspect for signs of damage, oil or fuel leaks.
 - b. Remove excessive dirt and/or debris from the unit.
2. Check Suction and Discharge Hoses.
 - a. Inspect general condition of hoses to ensure hoses are in serviceable condition.
 - i. Suction Hose must be reinforced construction to prevent hose collapse.
 - b. Ensure sealing washer in suction hose connector is in operable condition.
 - c. Ensure hose connectors and clamps are securely installed.
 - d. Ensure filter is in operable condition and securely installed on suction hose.
3. Check the Engine.
 - a. Ensure proper engine oil amount.
 - b. Ensure air cleaner element is clean and installed.
 - c. Ensure proper fuel level amount.
4. Ensure water pump is on a level surface.
5. Ensure engine switch is in the "OFF" position.
6. Ensure water pump is at least 3ft (1m) away from building walls and other equipment during operation. Do NOT place flammable objects close to water pump.

Operation of Water Pump (continued)

Starting the Engine:

1. Prime the pump.
2. Move the fuel cock to the "ON" position.
3. To start a cold engine, push the choke lever to the "CLOSED" position (Refer to Diagram 1 below.)
To restart a warm engine, leave the choke level in the "OPEN" position.
4. Move the throttle valve lever slightly to the "FAST" position. (Refer to Diagram 2 below.)
5. Turn the engine switch to the "ON" position (Refer to Diagram 3 below.)
6. Pull the recoil starting handle lightly until resistance is felt, then pull briskly. Do NOT allow the starter handle to snap back against the engine. Return it gently to prevent damage to the starter.
7. Once the engine has started, gradually move the choke lever to the "OPEN" position.

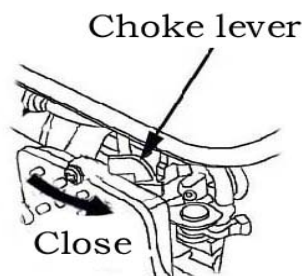

DIAGRAM 1

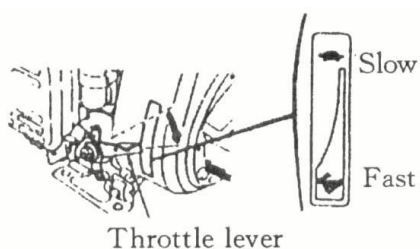

DIAGRAM 2

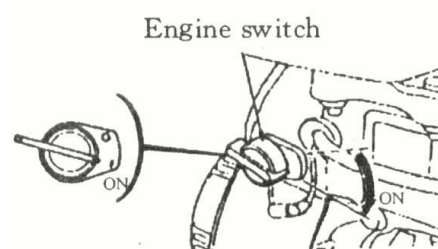
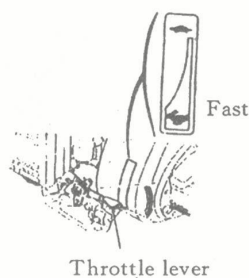

DIAGRAM 3

Setting the Engine Speed

1. After starting the engine, move the throttle valve lever to the "FAST" position for self-priming, then check the pump output.
2. To adjust the pump output (which is controlled by the engine speed), move the throttle valve lever as needed to attain desired pump output. Moving the throttle valve in the "FAST" direction will increase the pump output and moving the throttle valve in the "SLOW" direction will decrease pump output.



Operation of Water Pump (continued)

Stopping the engine:

IN EMERGENCY:

1. Turn the engine switch to the "OFF" position.

NORMAL PROCEDURE:

1. Move the throttle valve lever to the "SLOW" position.
2. Turn the engine switch to the "OFF" position.
3. Turn the fuel cock to the "OFF" position.
4. Remove the water drain plug and drain the pump chamber.
5. Remove the water filler cap and flush the pump chamber with fresh, clean water.
6. Allow water to completely drain from the pump chamber.
7. Reinstall the water drain plug.
8. Reinstall the water filler cap.

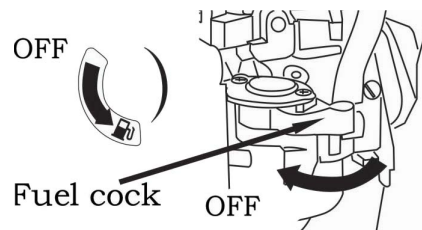
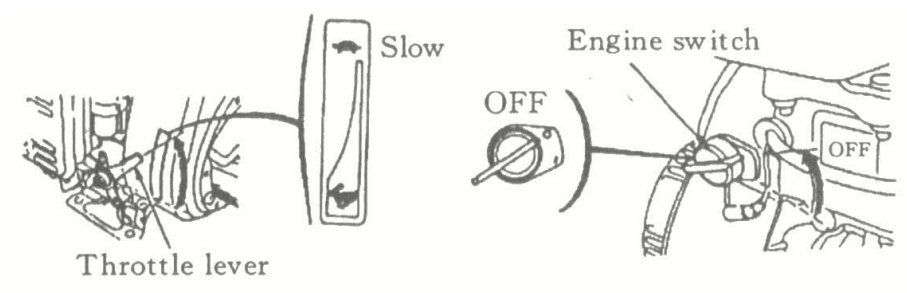

Transporting and Storing the Unit



CAUTION:

- To avoid fire, allow water pump to cool down for at least twenty (20) minutes before transporting or storing the unit.
- Always transport and store the unit with the fuel cock in the “OFF” position.
- Always keep unit in horizontal position to the ground to prevent fuel from spilling. Spilled gasoline and gasoline vapor may ignite.
- Gasoline is extremely flammable and explosive.

Storing the Water Pump:

1. Ensure the storage site for the unit is clean and dry.
2. Clean the inside of the water pump.
 - a. If the water pump was used to pump water with mud, sand, or other heavy debris:
 - i. Operate water pump to suck in fresh, clean water to wash inside of unit. Failure to do so may result in damage to impeller.
 - ii. After washing, remove water drain plug and empty the water in the water pump completely.
 - iii. Reinstall the water drain plug.

Before long term storage of your power equipment product, typically 30 days or more, perform the following:

3. Set the fuel cock (valve) to the “OFF” position.
4. Let the unit continue to run until it stops itself, burning all of the fuel in the fuel system.
5. Turn the ignition switch to the “OFF” position.
6. Drain the engine oil in accordance with the “Oil Change Procedures” in this Owner’s Manual’s Maintenance section. Do NOT re-fill with oil until ready to use again.
7. Remove the Spark Plug in accordance with the “Spark Plug Maintenance” in the Owner’s Manual’s Maintenance section. Spray a lubricant, such as WD40®, into the Spark Plug hole to lubricate the top of the piston and walls of the cylinder. Replace the Spark Plug.
8. Pull starter rope until resistance is felt. This will place the valves in the closed position.

Transporting and Storing the Unit (continued)

9. Add the recommended amount of fuel stabilizer, in accordance with the amount recommended by the manufacturer of the fuel stabilizer, to the unused gasoline left in the unit's tank.
10. Place the unit in a clean, dry, and secure location.
11. Cover the unit to protect from dust.

Maintenance

MAINTENANCE SCHEDULE	
PROCEDURE	TIME
Engine Oil Check	Each Use
Replace Engine Oil	After Each 40 Hours of Use (For Initial Break in – After First (1 st) 10 Hours of Use
Air Cleaner Filter	Check Each Use/Replace As Needed or After Every 100 Hours of Use
Impeller Check	After 300 Hours of Use or After First Year
Air Cleaner Wash	When Needed
Spark Plug	When Needed
Valve Clearance	Check & Re-adjust annually or after 300 Hours of Use
Fuel Tank	Replace Every 3 Years Based on Condition

NOTE: Refer to Following Procedures for Proper Method to Perform Maintenance

OIL CHANGE PROCEDURES:

Periodic Maintenance of your engine oil should be performed after each 40 hours of use of you Power Equipment Product. Check your engine oil level prior to each use.

1. Start your engine and let it warm up to get the oil warm and thinner. Remove the dipstick by turning counter clockwise. Remove the oil drain plug located below the dipstick utilizing the appropriate tools.

CAUTION: THE OIL MAY BE HOT.

2. Drain the engine oil into an approved receptacle and discard in accordance with all Federal and State Regulations. Never dump your used engine oil on the ground or into drains, only discard in an approved manner. Check with your local authorities to determine the regulations in your area.

WARNING! AVOID SPLASHING OF HOT OIL; IT CAN BURN YOU AND CAUSE SEVERE INJURY.

3. After oil is completely drained, replace oil drain plug and tighten with appropriate tools. Replace oil with the proper oil for your product. Refer to the Pre-Operating Instructions: Engine Oil Level Check section for exact fill requirements. Always use your dipstick to check the oil level and only fill to the full mark on the dipstick. Never overfill the engine, as this can cause damage to the unit and void warranty.

Maintenance (continued)

OIL CHANGE PROCEDURES (continued):

4. Replace the dipstick on your engine.

PROPER MAINTENANCE OF YOUR UNIT WILL INCREASE THE LIFE OF YOUR PRODUCT. THE OIL MUST BE CHANGED ON A REGULAR BASIS FOR PROPER OPERATION, AND RELIABILITY AND TO ALSO MAINTAIN YOUR WARRANTY ON THIS PRODUCT.

AIR CLEANER MAINTENANCE:

1. Remove the clip (item 9 in "Air Cleaner A" below) or the wing nut (item 7 in "Air Cleaner B" below) to remove and check the air filter element.
2. For Sponge Type Air Filters, wash with soap and water when contaminated. Squeeze excess liquid from air filter element, and allow the air filter element to dry.
For Paper Type Air Filters, replace with the correct Air Filter for your unit. They are available at your dealer or from LIFAN Power USA. Order your filter by calling toll free 866-471-7464.
3. Re-Install the air filter element into the air filter housing.

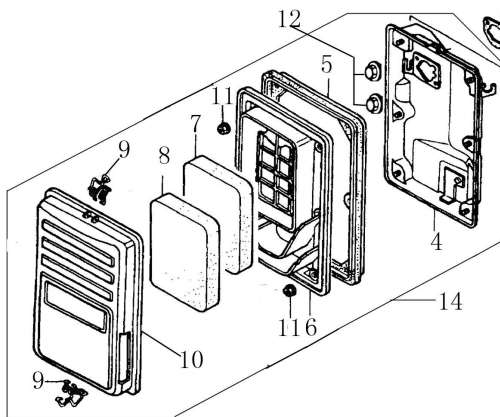

Air Cleaner A

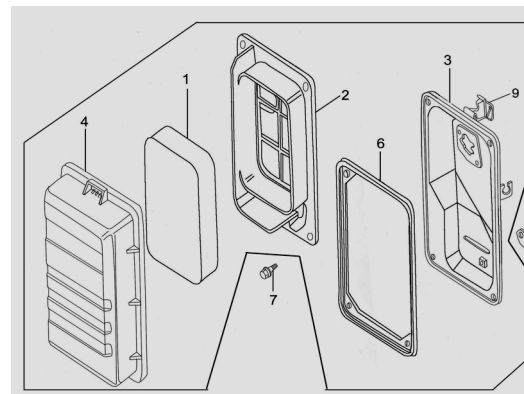

Air Cleaner B

Maintenance (continued)

SPARK PLUG MAINTENANCE:

1. Remove Spark Plug Cap (refer to "Spark Plug Cap Removal" figure below.)
2. Remove Spark Plug with socket and handle supplied with your unit (refer to "Spark Plug Removal" figure below.)
3. Clean any carbon build-up around the Spark Plug.
4. Check the Spark Plug Gap and adjust if necessary. 0.6mm – 0.7mm gap.
5. Lubricate the threads of the spark plug with anti-seize compound or engine oil.
6. Re-install the Spark Plug and Spark Plug Cap.

FUEL SYSTEM MAINTENANCE:

NOTE: Periodically you can get sediment or trash in your Carburetor Bowl. Use the following procedures to clean:

1. Turn the fuel cock (valve) to the "OFF" Position.
2. Remove the carburetor bowl by removing the mounting bolt located at the bottom of the bowl.
3. Dump out the old fuel and sediment into an approved container
4. Clean carburetor bowl thoroughly.
5. Fit a new rubber washer into place and re-attach fuel bowl to the carburetor.

NOTE: Removal of the drain screw at the bottom of the bowl can drain the fuel to remove smaller debris that has collected in the bowl.

6. After bowl is securely back in place, turn the fuel cock (valve) to the "ON" position for use.
7. Units equipped with a pre-filter for fuel will have a filter housed just below the fuel cock. Remove the fuel filter element (refer to "Fuel Filter Element Removal") and clean or replace.

Maintenance (continued)

FUEL SYSTEM MAINTENANCE (continued):

diagram below) and either clean or replace the fuel filter element. Re-assemble the fuel filter element (refer to “Fuel Filter Element Assembly” diagram below.)



Fuel Filter Element Removal

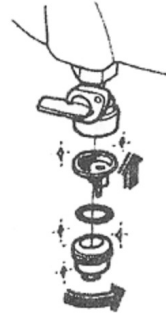

Fuel Filter Element Assembly

USAGE IN HIGH ALTITUDE REGIONS:

In regions with high altitude, the standard carburetor produces overly dense combinations of fuel and air, which result in decreased engine performance and increased fuel consumption. To maintain high engine performance at high altitudes, install a high altitude carburetor main spray nozzle and re-adjust the adjusting screw for idle speed. For usage in regions with an altitude of over 4,527ft (1380m), contact your dealer to replace the standard carburetor and make needed adjustments in advance. Even with a proper high altitude carburetor spray nozzle installed in the engine, the power output of the engine will drop about 3.5% with every 1000ft (305m) increase in altitude. If the standard carburetor jets are not replaced and adjusted for usage in high altitude, the increased altitude effect will be even more severe.

NOTE: Usage of the water pump in regions with lower altitude than the high altitude carburetor spray nozzle is applicable, may result in decrease of engine performance. The engine may become overheated and over-lean combination of fuel and air produced, may cause severe damage to the engine.

Troubleshooting

IF THE ENGINE WILL NOT START:

1. Check to ensure switches are in the “ON” position.
2. Check engine oil level. The unit possesses a Low Oil Shutdown feature that will not allow your engine to start if the oil is below safe operating levels. This feature is installed to increase the life of your engine and prevent engine damage. If oil level is low, fill to the full mark on dipstick. Refer to the Pre-Operating Instructions: Engine Oil Check section for exact oil type and amounts.
3. Check the fuel level to insure adequate fuel. Add fuel if necessary.
4. Remove and inspect the spark plug for cleanliness and proper electrode gap. If needed, clean or replace the spark plug. Refer to Spark Plug Maintenance in the Maintenance section of the Owner’s Manual for proper procedure.
5. If the unit will still NOT start after performing the above checks, call our customer hotline at LIFAN Power USA Toll Free 1-866-471-7464 or take the unit to an authorized Service Center.

NOTE: Periodically on the initial start-up or after the unit has been stored for a long period of time, the float for your “Low Oil Shutdown” system will stick to the bottom of the oil pan. Locate the two (2) wires to the Low Oil Sensor Diode (figure “Low Oil Sensor Diode” to the right) located on the side of the engine block. Unplug these wires and, **only after ensuring the engine is full of oil**, start the engine and allow to run until warm (normally 20 minutes, as this will heat the oil and release the float on the Low Oil Shutdown System). Then re-plug the wires to the terminals on the Low Oil Shutdown Sending Unit.



IF THE WATER PUMP WILL NOT PUMP:

1. Check if there is ample water in the pump chamber to fully prime the pump.
2. Check if the filter is clogged on the suction hose.
3. Check if the hose clamp is securely tightened.
4. Check if the water hose is damaged.
5. Check if suction height required for the application is too high. Refer to Product Specifications section for unit maximum suction height.
6. If the water pump still will not pump water, call our customer hotline at LIFAN Power USA Toll Free 1-866-471-7464 or take the unit to an authorized Service Center.

Water Pump Safety

1. Never operate a gasoline engine powered product in any enclosed spaces, as they product deadly Carbon Monoxide Poisonous Gases.
2. Do NOT operate your power equipment in inclement weather such as rain, snow, and/or sleet.
3. Do NOT operate your power equipment within five (5) feet of any flammable materials.
4. When refueling your power equipment never smoke or refuel near any flame or ignition devices. Never refuel while the unit is running. If during the refueling process some fuel is spilled, always completely clean the fuel and allow sufficient drying time prior to re-starting your unit. Gasoline vapors ignite easily and are very dangerous.
5. NEVER ALLOW CHILDREN OR ANIMALS TO BE NEAR THIS EQUIPMENT DURING OPERATION. ONLY QUALIFIED PERSONS SHOULD OPERATE THIS EQUIPMENT. PLEASE FOLLOW ALL GUIDELINES CONTAINED IN THIS OWNER'S MANUAL FOR THE SAFE OPERATION OF THIS EQUIPMENT.



Limited Warranty Policy



This warranty is limited to the following LIFAN Power and Storm Series products that are distributed by the EquipSource LLC, dba LIFAN Power USA, located at 2205 Industrial Park Road, Van Buren, AR 72956. Effective 04/25/2010

LENGTH OF WARRANTY				
Products Covered	Residential Use ²			Commercial/Rental ³
	Year 1	Year 2	Year 3	Warranty NOT to exceed 300 hours or terms listed below:
Walk Behind Mowers	Full Unit: Parts & Labor	Full Unit: Parts Only	Engine: Parts Only	Full Unit: 3 Months Parts & Labor
Water Pumps	Full Unit: Parts & Labor	Full Unit: Parts Only	Engine: Parts Only	Full Unit: 12 Months Parts & Labor
Generators/Inverter Generators	Full Unit: Parts & Labor	Full Unit: Parts Only	Engine: Parts Only	Full Unit: 12 Months Parts & Labor
Pressure Washer Engines	Full Unit: Parts & Labor	Full Unit: Parts Only	Engine: Parts Only	Full Unit: 12 Months Parts & Labor
Pressure Washer Pumps ¹	Full Unit: Parts & Labor	N/A	N/A	Full Unit: 12 Months Parts & Labor
Gasoline Engines	Full Unit: Parts & Labor	Full Unit: Parts Only	Engine: Parts Only	Full Unit: 12 Months Parts & Labor
Gasoline Powered Welders	Full Unit: Parts & Labor	Full Unit: Parts Only	Engine: Parts Only	Full Unit: 6 Months Parts & Labor

Pressure Washer Pumps¹ - All LIFAN Pressure Pro™ and Storm Series Pressure Storm™ pressure washers are equipped with Anнови Reverbi  high pressure water pumps, which are warranted by the manufacturer's One (1) Year Limited Warranty. Visit www.lifanpowerusa.com for details.

Residential Use² - Residential Use is defined as items that are for personal use.

Commercial/Rental³ - Commercial or Rental use is defined as any usage for income producing or other business related uses.

In order to qualify for the limited warranty, the product(s) must be purchased in North America from an authorized EquipSource, LLC dealer, or a dealer authorized by EquipSource, LLC to sell LIFAN products. This warranty is non-transferable and applies only to the original purchaser. The supplied "Warranty Registration Card" must be completed and on file with EquipSource, LLC (at the supplied address), at the time that any warranty claim is made. The "Warranty Registration Card" must be submitted with a receipt of purchase, which clearly states the date of purchase.

During the warranty period (stated above), EquipSource, LLC will repair or replace, at its option, any part that is proven to be defective in material or workmanship under normal usage. Repairs and/or replacement will be made without charge for parts or labor. All parts found to be defective must be returned to EquipSource, LLC. Upon reception of the parts, a judgement as to the validity of the warranty claim will be determined. All parts replaced under warranty will be considered part of the original product and any warranty on those parts will coincide with the original warranty.

To obtain warranty service, you must take the product, at your expense, to an authorized LIFAN Power Products or Storm Series Power Products service center. If you are unable to locate warranty service or are dissatisfied with the warranty service that you receive, contact EquipSource, LLC at 866-471-7464. At EquipSource's discretion, EquipSource, LLC may elect to replace a defective unit. In this case, the end user is responsible for all shipping and handling charges associated with the exchange.

This warranty is not valid for products or parts affected or damaged by accident, collision, normal wear, fuel contamination, abuse, neglect, misuse, alteration, unsuitable use, and/or unauthorized parts replacement. Mower decks and blades are specifically not warranted for impact or abrasive damage. Warranty becomes void if the customer fails to install, maintain, and/or operate this product in accordance with the instructions and recommended actions of LIFAN set forth in the owner's manual. EquipSource, LLC disclaims any responsibility for time loss or loss of usage of the product, transportation, commercial loss, or any other incidental or consequential damage. Prior to any warranty service an approval code must be issued to the service center in order for the warranty claim to be valid. Any implied warranties are limited to the duration of this written limited warranty. This warranty gives you specific legal rights, and you may also have other rights, which may vary from state to state.

Exclusions to Warranty:

- Failure to perform "Periodic Maintenance" as required and specified in the supplied "Owner's Manual."
- Improper repair of product or replacement of parts with non-OEM (Original Equipment Manufacturer) parts.
- Operation in uses and methods other than those outlined in the "Owner's Manual."
- Service and/or repairs performed by anyone other than an "Authorized LIFAN or Storm Series Products Service Center."

More Information Available on our website: www.lifanpowerusa.com EquipSource, LLC

2010 Revised 04/25/2010

26
 LIFAN Power USA
 2205 Industrial Park Road
 Van Buren, AR 72956
 866-471-7464
www.lifanpowerusa.com



**Please Read this Owner's Manual Carefully Before Operating
Your New Water Pump.**

**This Owner's Manual includes the operation and maintenance of
the LF1.5WP and LF1.5WP-CA**

Thank you for purchasing our Pro Series Water Pump!

All information in this publication is based on the latest product information available at the time of approval for printing. We reserve the right to make changes at any time without notice and without incurring any obligation. The copyright of this manual belongs to EquipSource, LLC. No parts of this publication may be reproduced without the written consent of EquipSource, LLC. This manual should be considered a permanent part of the generator and should remain with it if is resold.

**For Product Support and Service Please Scan the QR Code Below
or Visit Us at www.lifanpowerusa.com or Call Toll Free 1-866-
471-7464**



27

LIFAN Power USA
2205 Industrial Park Road
Van Buren, AR 72956
866-471-7464
www.lifanpowerusa.com

