



SCALA2



<http://qr.grundfos.com/i/scala2install>



PN10:
Max. 10 bar/1.0 MPa



- Voltage
- Ambient temperatur



Min./Max.
0 °C – 45 °C /
32 °F – 113 °F

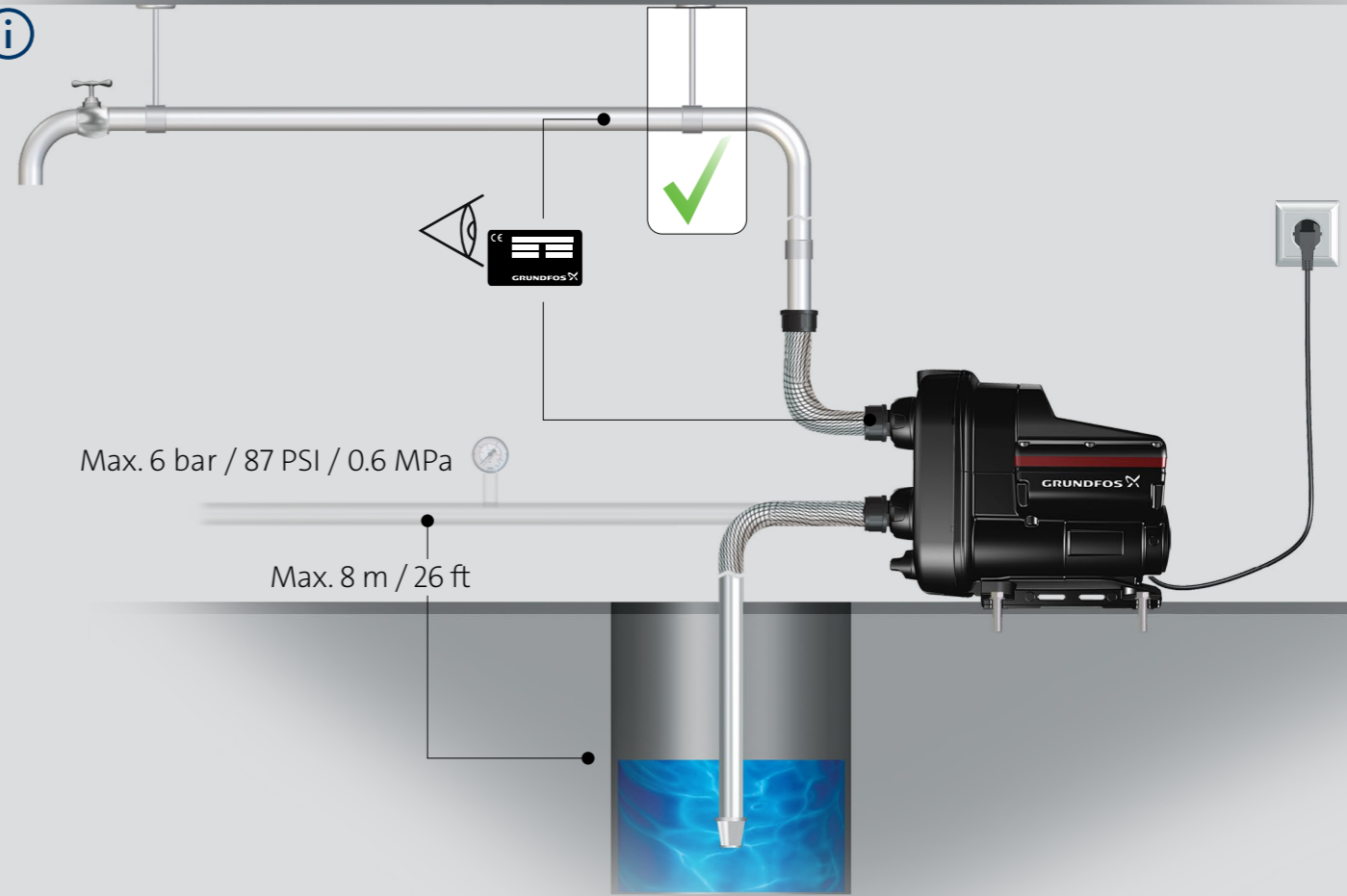
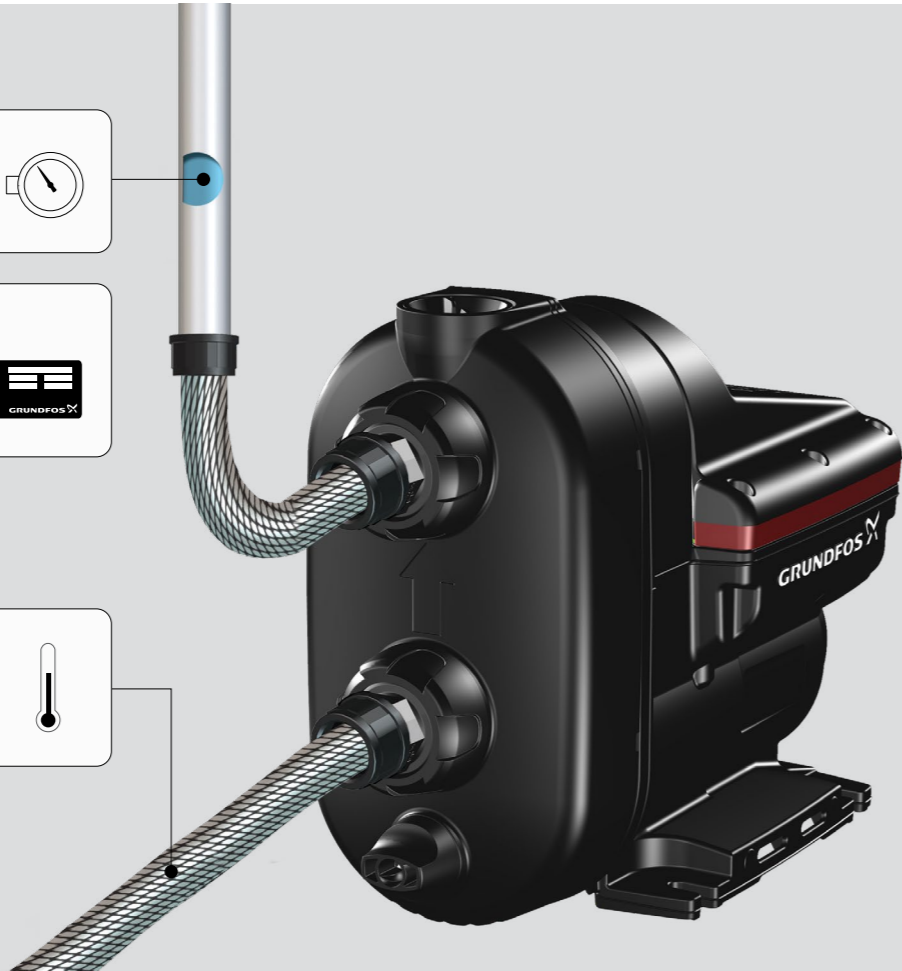

Max. 6 bar / 87 PSI / 0.6 MPa

Max. 8 m / 26 ft

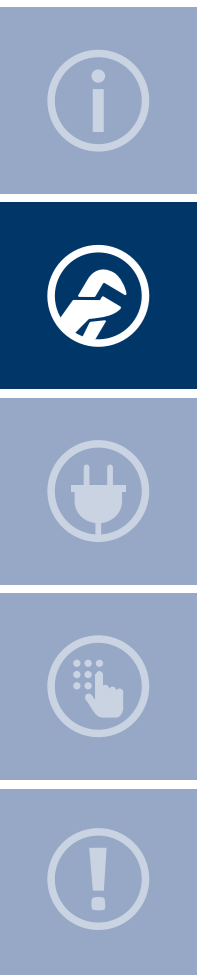

1

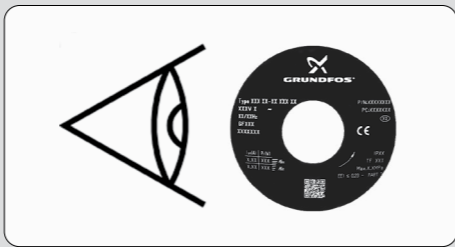

2



<http://qr.grundfos.com/i/scala2install>

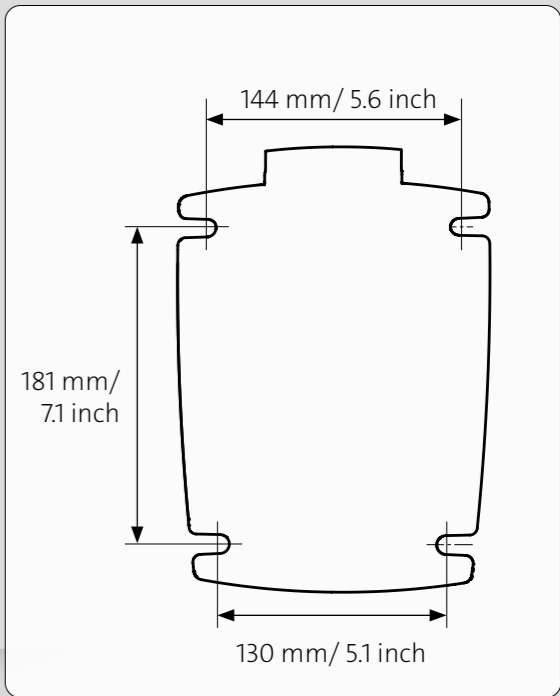

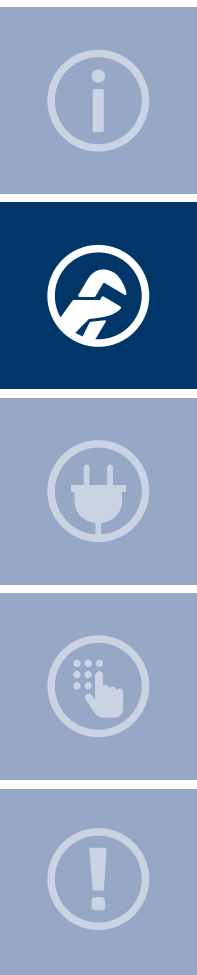

3

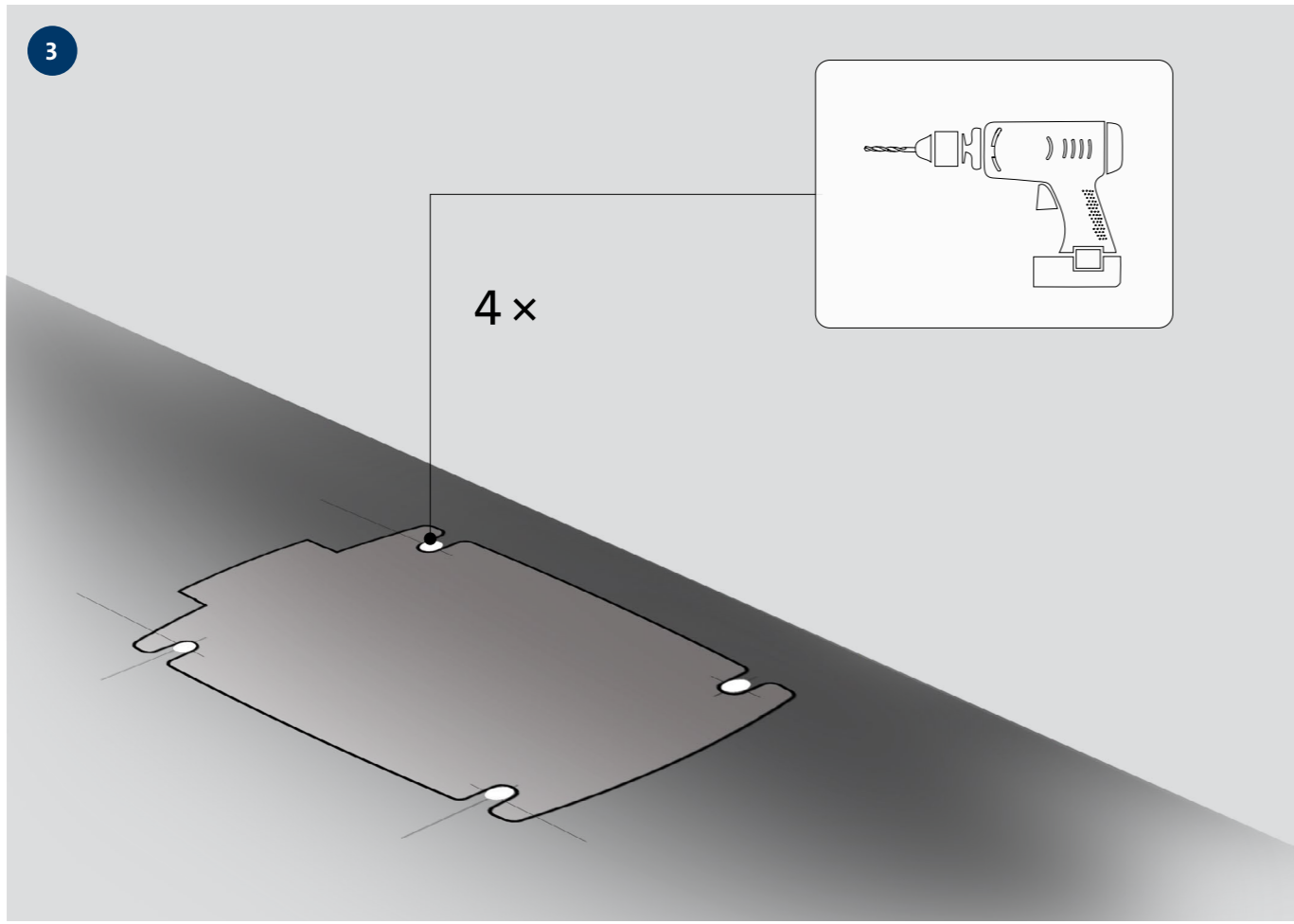

4

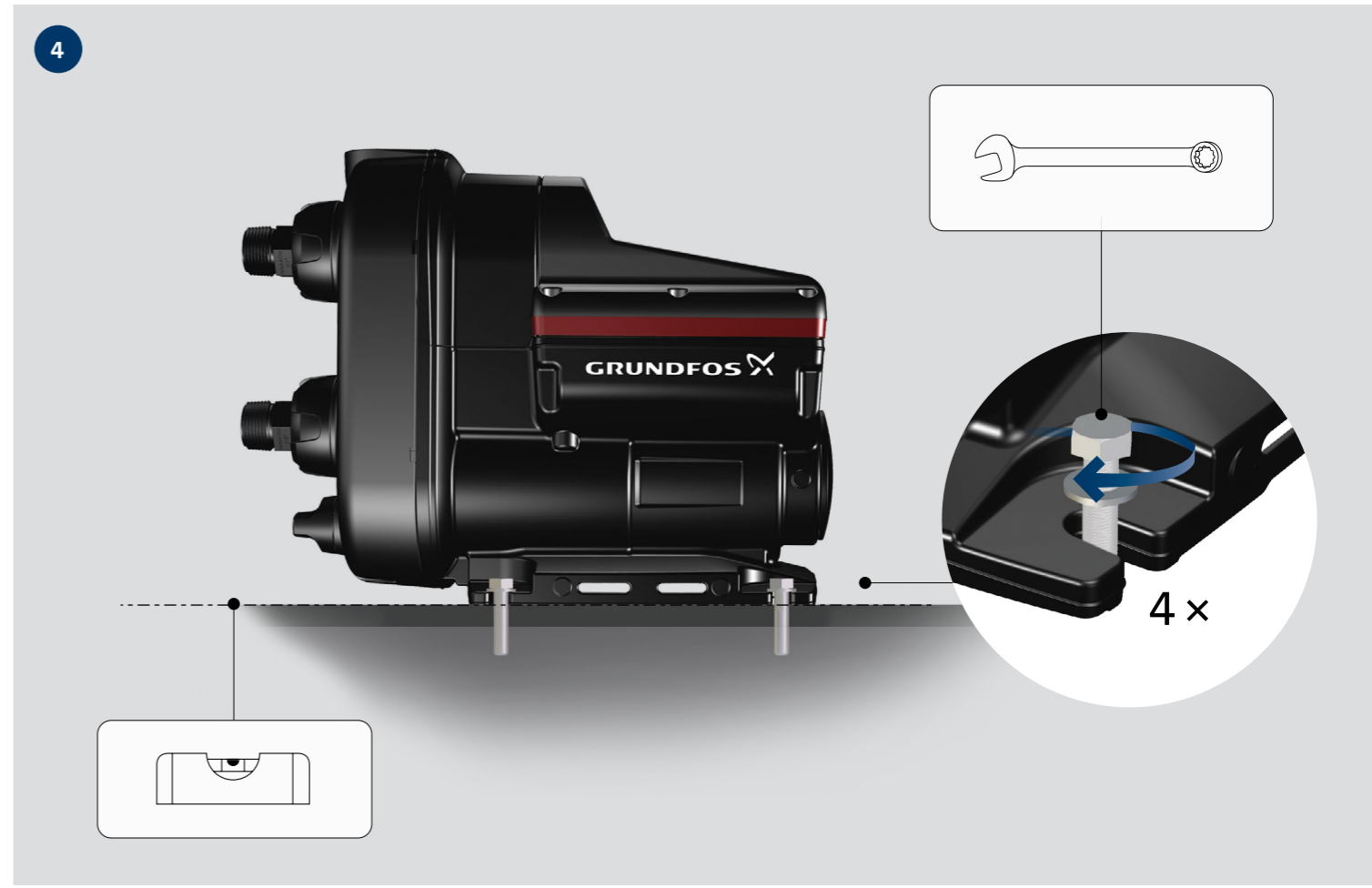

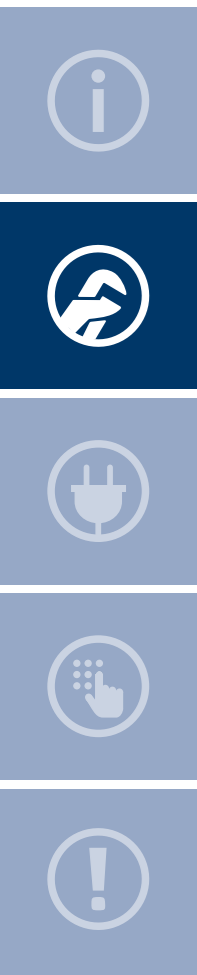

5

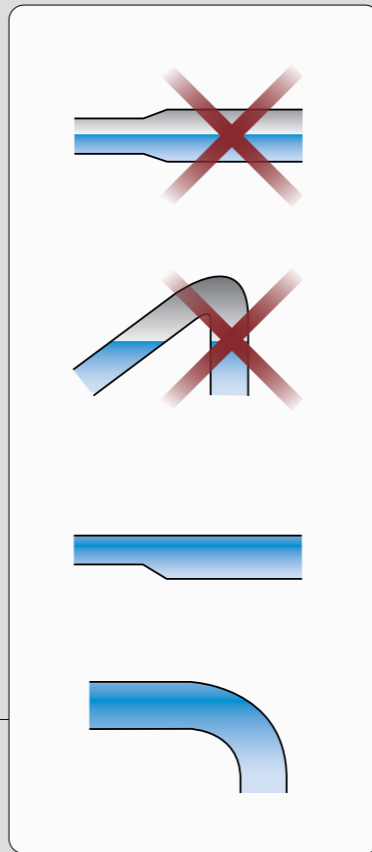
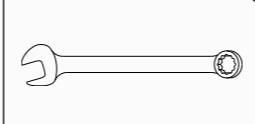
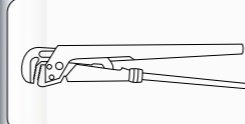
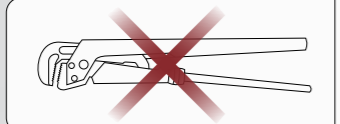

5A



5B



5C



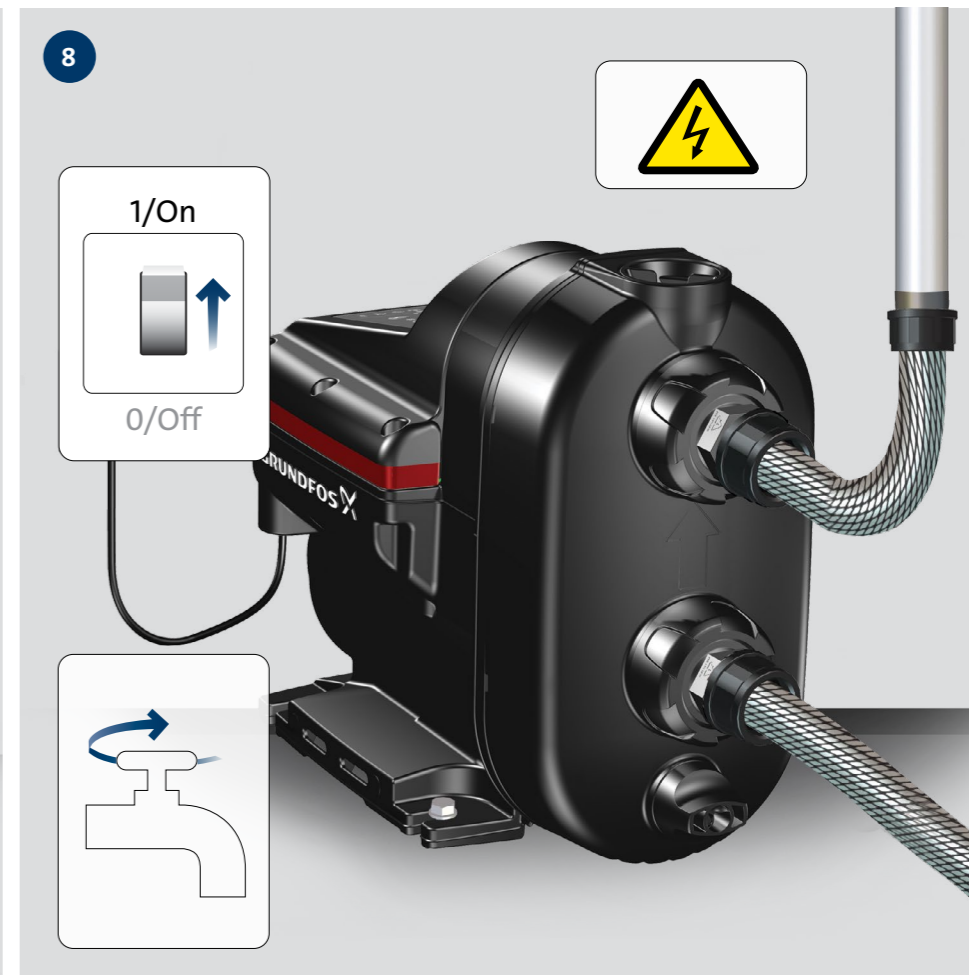
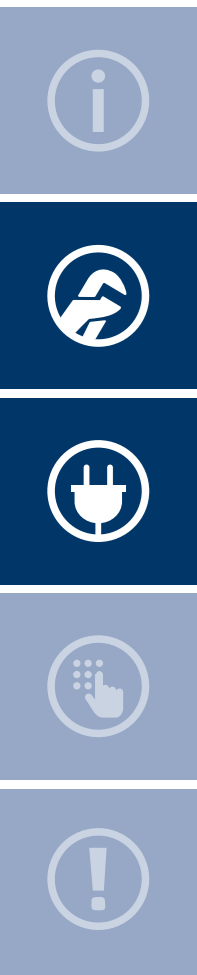

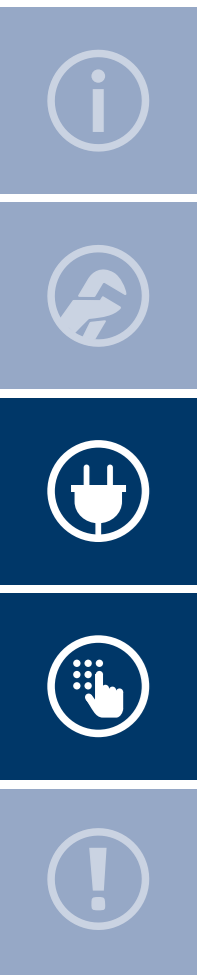

9

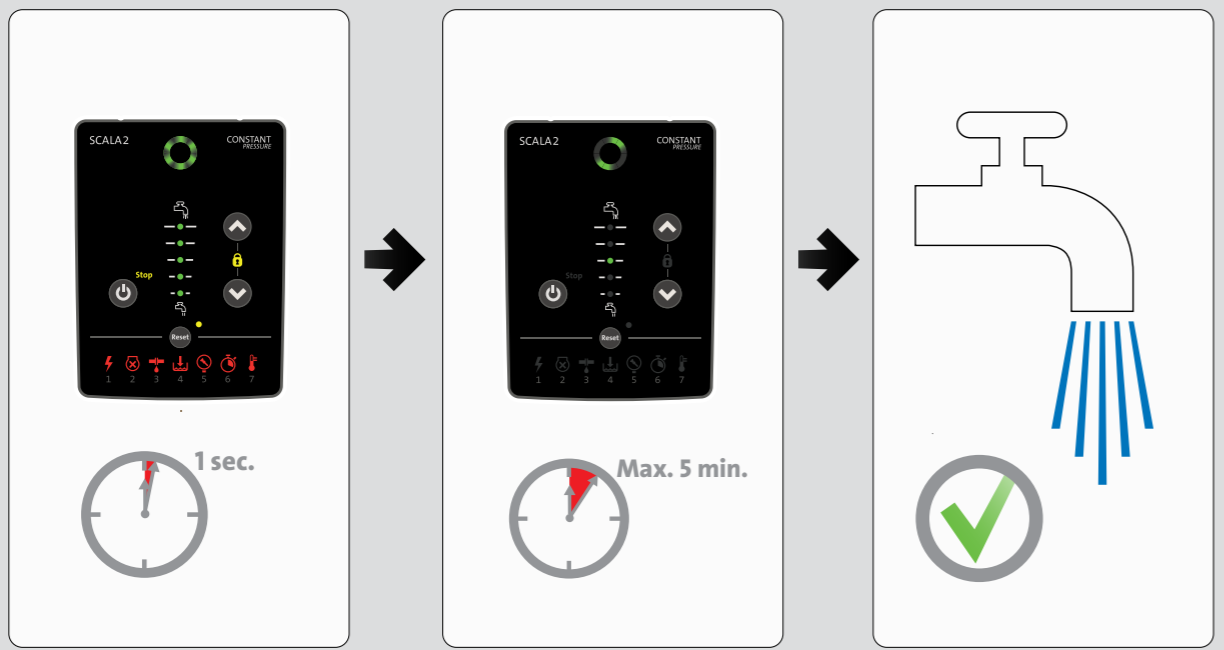

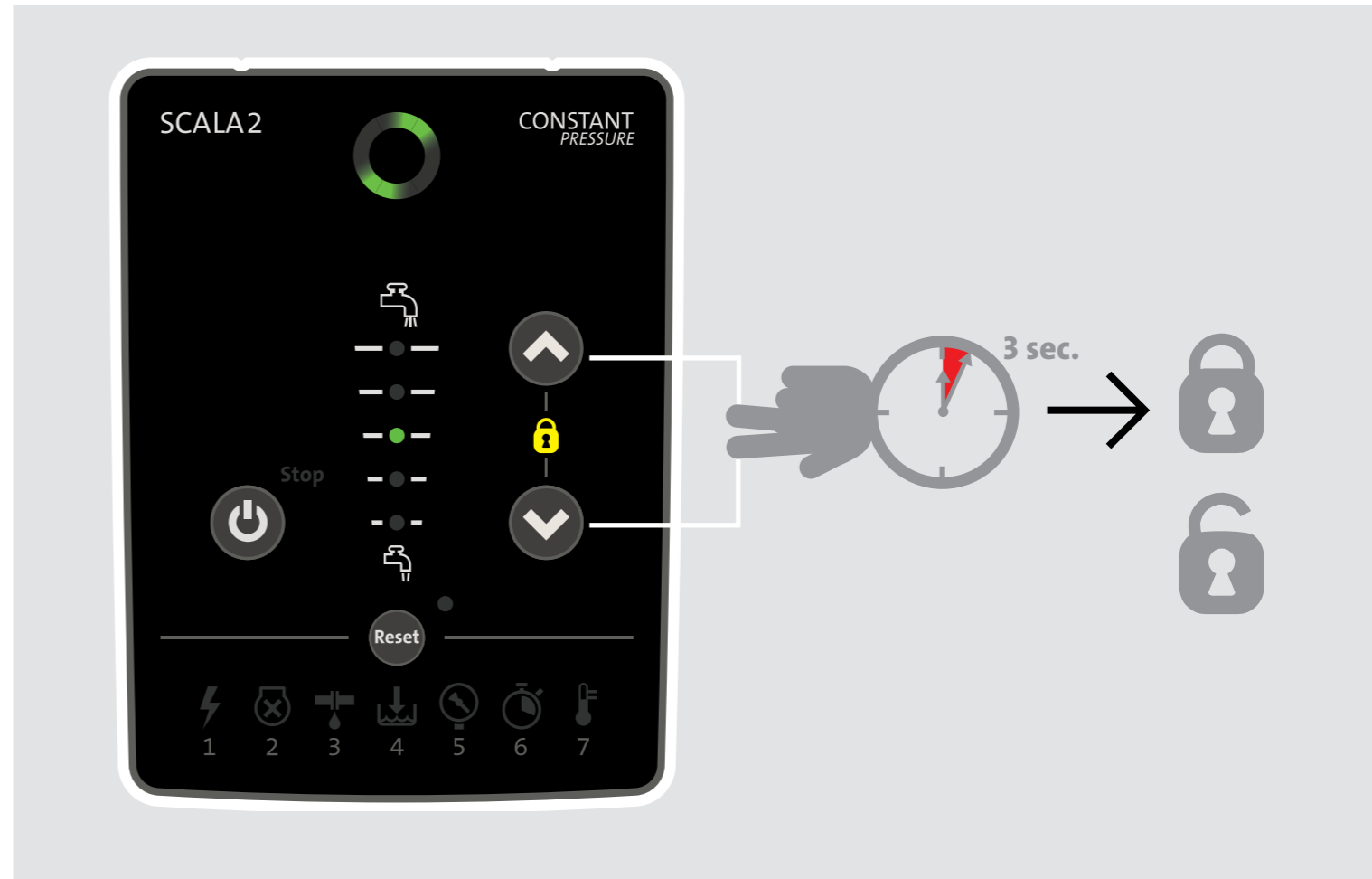
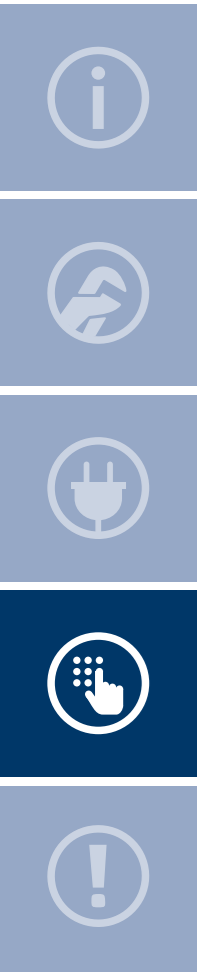

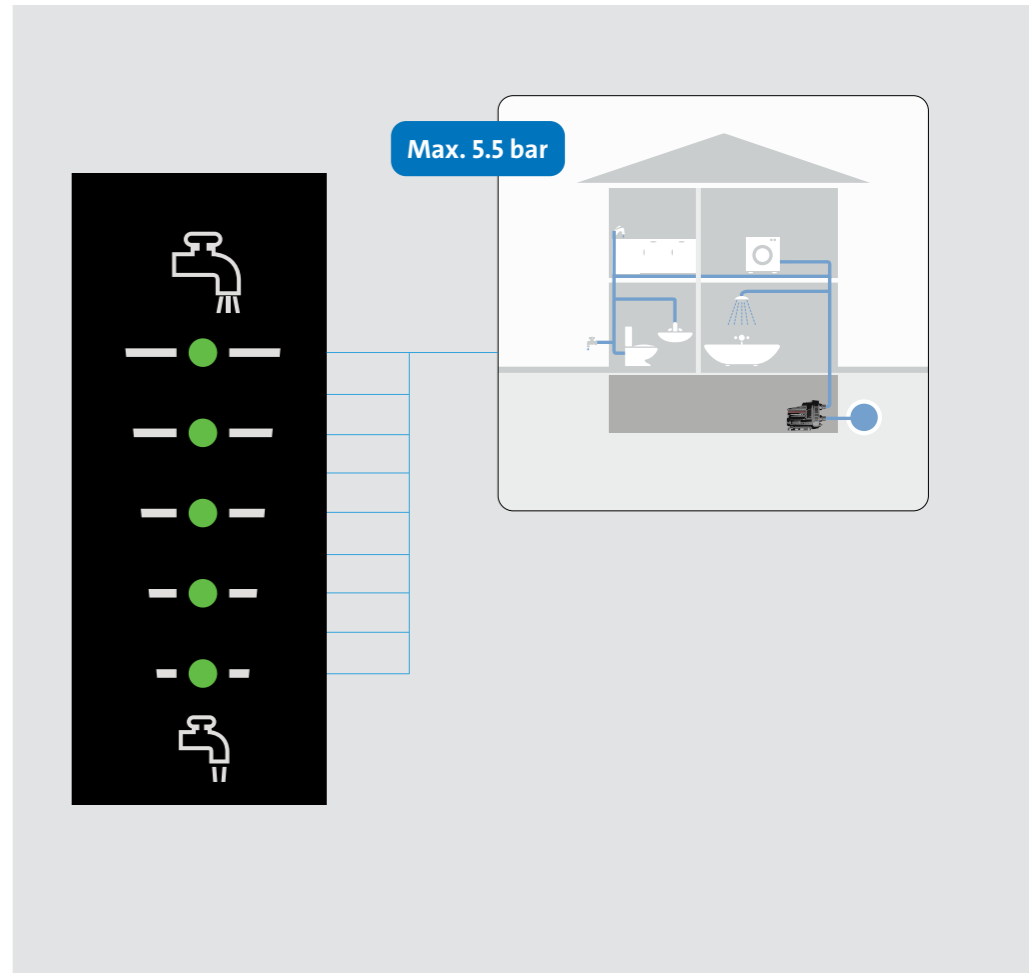
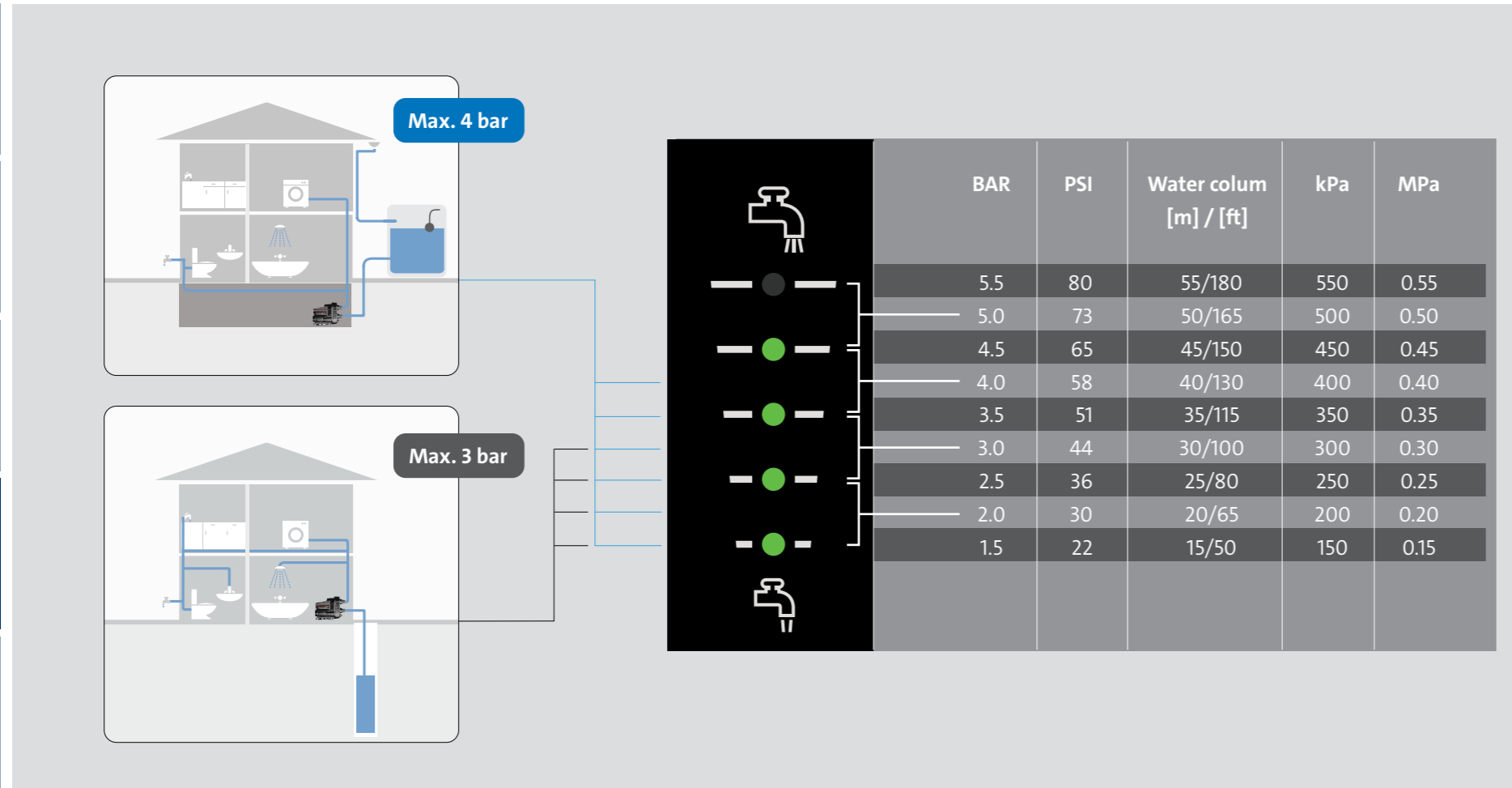
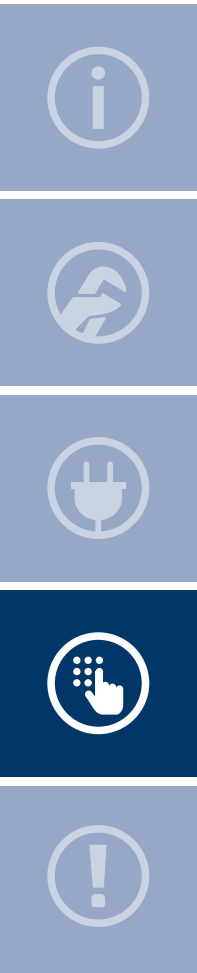

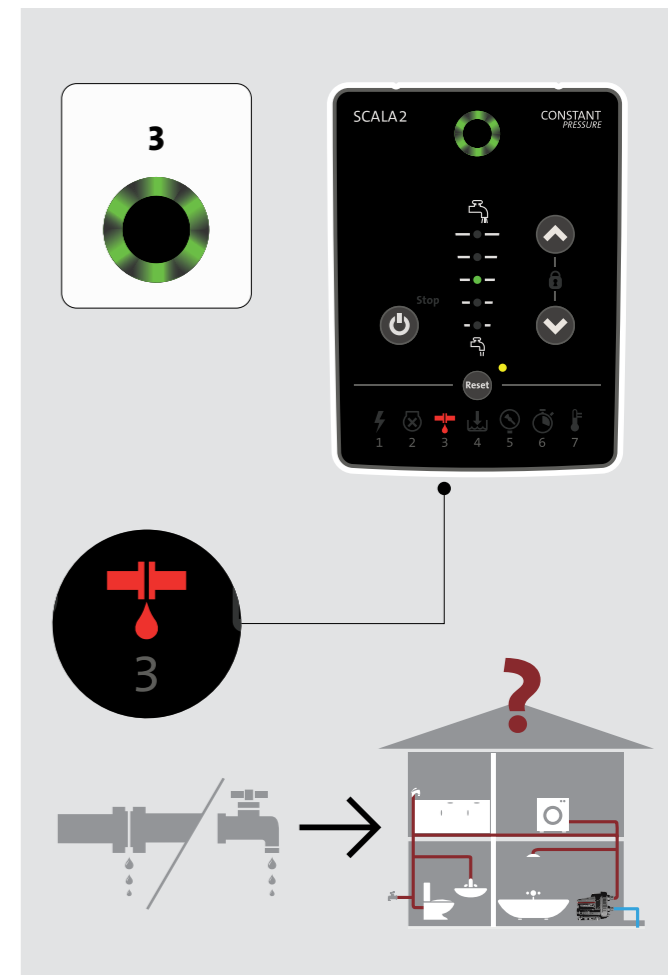
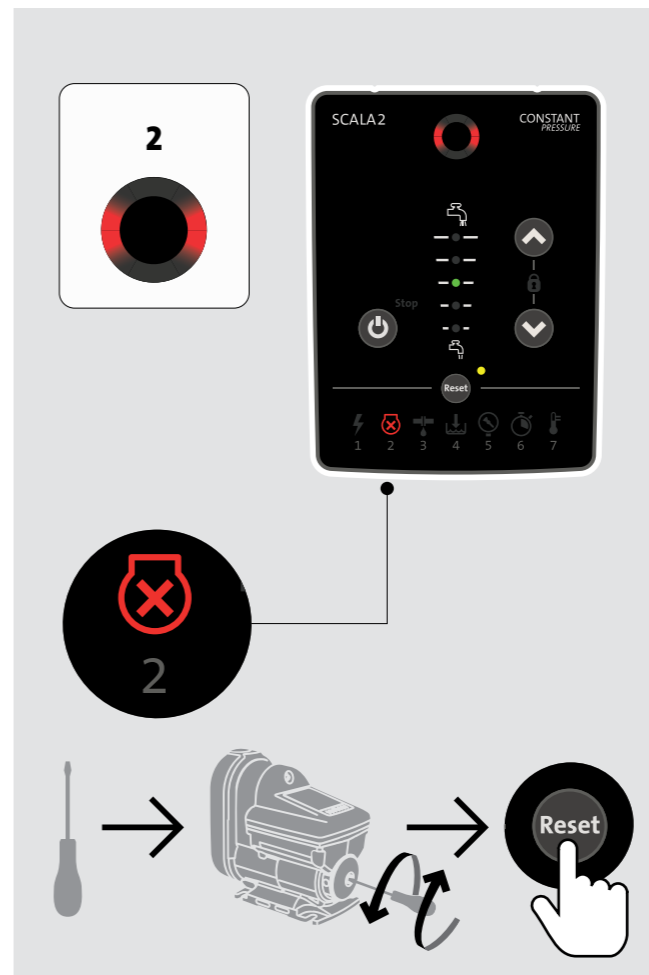
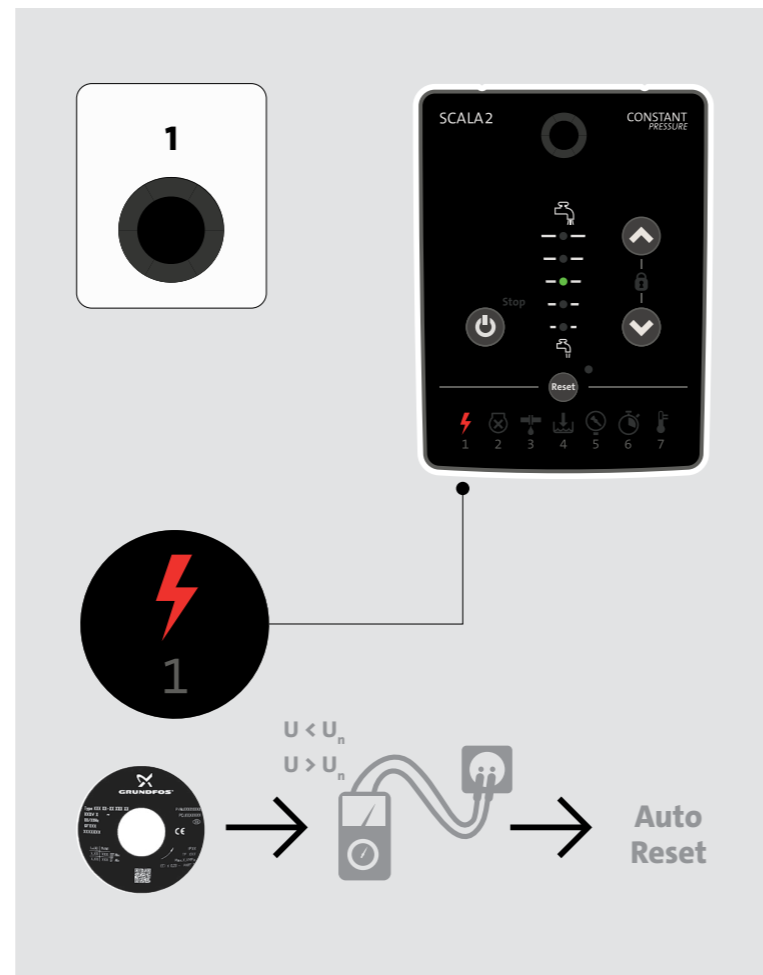
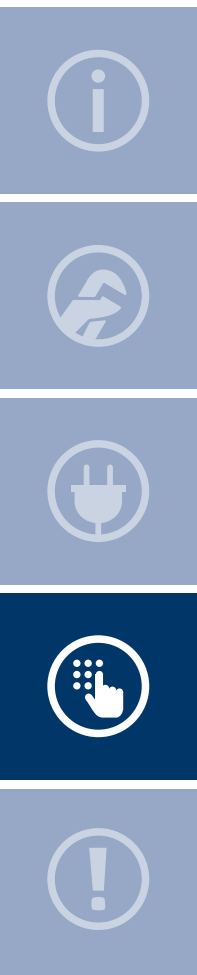

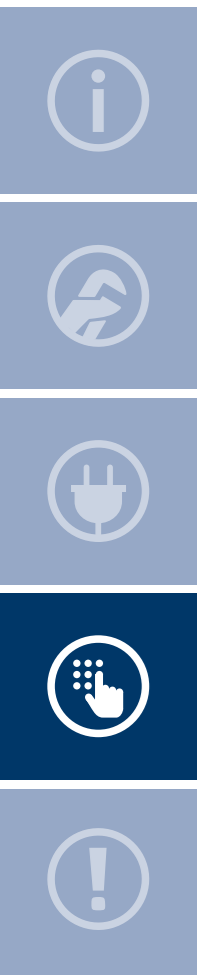

4

SCALA2 CONSTANT PRESSURE

Stop

Reset

1 2 3 4 5 6 7

5

SCALA2 CONSTANT PRESSURE

Stop

Reset

1 2 3 4 5 6 7

6

SCALA2 CONSTANT PRESSURE

Stop

Reset

1 2 3 4 5 6 7

30 min.

7

SCALA2 CONSTANT PRESSURE

Stop

Reset

1 2 3 4 5 6 7



net.grundfos.com/qr/i/98880508

98501666	
ECM: 1361638	02.2023

GRUNDFOS Holding A/S

Poul Due Jensens Vej 7

DK-8850 Bjerringbro

Tel: +45 87 50 14 00

www.grundfos.com

GRUNDFOS 

The name Grundfos, the Grundfos logo are registered trademarks owned by Grundfos Holding A/S or Grundfos A/S, Denmark. All rights reserved worldwide.