

BARNES®

BARNES
PRESSURE SYSTEMS

CROWN

burks®

WEINMAN®

DEMING®

PROSSER®

Limited 24 Month Warranty

Crane Pumps & Systems warrants that products of our manufacture will be free of defects in material and workmanship under normal use and service for twenty-four (24) months after manufacture date, when installed and maintained in accordance with our instructions. This warranty gives you specific legal rights, and there may also be other rights which vary from state to state. In the event the product is covered by the Federal Consumer Product Warranties Law (1) the duration of any implied warranties associated with the product by virtue of said law is limited to the same duration as stated herein, (2) this warranty is a LIMITED WARRANTY, and (3) no claims of any nature whatsoever shall be made against us, until the ultimate consumer, his successor, or assigns, notifies us in writing of the defect, and delivers the product and/or defective part(s) freight prepaid to our factory or nearest authorized service station. Some states do not allow limitations on how long an implied warranty lasts, so the above limitation may not apply. **THE SOLE AND EXCLUSIVE REMEDY FOR BREACH OF ANY AND ALL WARRANTIES WITH RESPECT TO ANY PRODUCT SHALL BE TO REPLACE OR REPAIR AT OUR ELECTION, F.O.B. POINT OF MANUFACTURE OR AUTHORIZED REPAIR STATION, SUCH PRODUCTS AND/OR PARTS AS PROVEN DEFECTIVE. THERE SHALL BE NO FURTHER LIABILITY, WHETHER BASED ON WARRANTY, NEGLIGENCE OR OTHERWISE.** Unless expressly stated otherwise, guarantees in the nature of performance specifications furnished in addition to the foregoing material and workmanship warranties on a product manufactured by us, if any, are subject to laboratory tests corrected for field performance. Any additional guarantees, in the nature of performance specifications must be in writing and such writing must be signed by our authorized representative. Due to inaccuracies in field testing if a conflict arises between the results of field testing conducted by or for user, and laboratory tests corrected for field performance, the latter shall control. **RECOMMENDATIONS FOR SPECIAL APPLICATIONS OR THOSE RESULTING FROM SYSTEMS ANALYSES AND EVALUATIONS WE CONDUCT WILL BE BASED ON OUR BEST AVAILABLE EXPERIENCE AND PUBLISHED INDUSTRY INFORMATION. SUCH RECOMMENDATIONS DO NOT CONSTITUTE A WARRANTY OF SATISFACTORY PERFORMANCE AND NO SUCH WARRANTY IS GIVEN.**

This warranty shall not apply when damage is caused by (a) improper installation, (b) improper voltage (c) lightning (d) excessive sand or other abrasive material (e) scale or corrosion build-up due to excessive chemical content. Any modification of the original equipment will also void the warranty. We will not be responsible for loss, damage or labor cost due to interruption of service caused by defective parts. Neither will we accept charges incurred by others without our prior written approval.

This warranty is void if our inspection reveals the product was used in a manner inconsistent with normal industry practice and/or our specific recommendations. The purchaser is responsible for communication of all necessary information regarding the application and use of the product. **UNDER NO CIRCUMSTANCES WILL WE BE RESPONSIBLE FOR ANY OTHER DIRECT OR CONSEQUENTIAL DAMAGES, INCLUDING BUT NOT LIMITED TO TRAVEL EXPENSES, RENTED EQUIPMENT, OUTSIDE CONTRACTOR FEES, UNAUTHORIZED REPAIR SHOP EXPENSES, LOST PROFITS, LOST INCOME, LABOR CHARGES, DELAYS IN PRODUCTION, IDLE PRODUCTION, WHICH DAMAGES ARE CAUSED BY ANY DEFECTS IN MATERIAL AND/OR WORKMANSHIP AND/OR DAMAGE OR DELAYS IN SHIPMENT. THIS WARRANTY IS EXPRESSLY IN LIEU OF ANY OTHER EXPRESS OR IMPLIED WARRANTY, INCLUDING ANY WARRANTY OF MERCHANTABILITY OR FITNESS FOR A PARTICULAR PURPOSE.**

No rights extended under this warranty shall be assigned to any other person, whether by operation of law or otherwise, without our prior written approval.

IMPORTANT! WARRANTY REGISTRATION

Your product is covered by the enclosed Warranty.
To complete the Warranty Registration Form go to:

<http://www.cranepumps.com/ProductRegistration/>

If you have a claim under the provision of the warranty, contact your local
Crane Pumps & Systems, Inc. Distributor.

RETURNED GOODS

RETURN OF MERCHANDISE REQUIRES A "RETURNED GOODS AUTHORIZATION".
CONTACT YOUR LOCAL CRANE PUMPS & SYSTEMS, INC. DISTRIBUTOR.



Products Returned **Must Be Cleaned, Sanitized, Or Decontaminated As Necessary Prior To Shipment, To Insure That Employees Will Not Be Exposed To Health Hazards In Handling Said Material. All Applicable Laws And Regulations Shall Apply.**

BARNES®

INSTALLATION MANUAL Portable Utility Pump

Series: BT12
115 Volts, 1 Phase, 60 Hz



Specifications

Model No.	BT12
Part No.	134677
Output	1/12 HP
	62 W
Rated Head	10'
Rated Flow	5 GPM

IMPORTANT!

*Read all instructions in this manual before operating pump.
As a result of Crane Pumps & Systems, Inc., constant product improvement program,
product changes may occur. As such Crane Pumps & Systems reserves the right to
change product without prior written notification.*

CRANE®

A Crane Co. Company

PUMPS & SYSTEMS

420 Third Street
Piqua, Ohio 45356
Phone: (937) 778-8947
Fax: (937) 773-7157
www.cranepumps.com

83 West Drive, Brampton
Ontario, Canada L6T 2J6
Phone: (905) 457-6223
Fax: (905) 457-2650

Form No. 134677A-Rev. A

SAFETY FIRST!

Please Read This Before Installing Or Operating Pump. This information is provided for SAFETY and to PREVENT EQUIPMENT PROBLEMS. To help recognize this information, observe the following symbols:

 **IMPORTANT!** Warns about hazards that can result in personal injury or indicates factors concerned with assembly, installation, disassembly, or maintenance which could result in damage to the machine or equipment if ignored.

 **WARNING!** Warns about hazards that can or will cause serious personal injury, death, or major property damage if ignored. Used with symbols below.

 **Biohazard can cause serious personal injury.** Explosions could cause personal injury or property damage.

 **Amputation or severe shock, burn or cause death.** Hazardous machinery

 **Shock, burn or cause death.** Hazardous voltage, burn or

 **WARNING!** To reduce risk of electrical shock, pumps and control panels must be properly grounded in accordance with the National Electric Code (NEC) or the Canadian Electrical Code (CEC) and all applicable state, province, local codes and ordinances. Improper grounding voids warranty.

 **WARNING!** To reduce risk of electrical shock, always disconnect the pump from the power source before handling or servicing. Lock out power and tag.

 **WARNING!** Operation against a closed discharge valve will cause premature bearing and seal failure on any pump, and on end suction and self priming pump the heat build up may cause the generation of steam with resulting dangerous pressures. It is recommended that a high case temperature relief valve be installed on the pump body.

 **CAUTION!** Never operate a pump with a plug-in type power cord without a ground fault circuit interrupter.

 **WARNING!** Do not pump hazardous materials (flammable, caustic, etc.) unless the pump is specifically designed and designated to handle them.

 **CAUTION!** Do not wear loose clothing that may become entangled in moving parts.

 **WARNING!** Keep clear of suction and discharge openings. **DO NOT** insert fingers in pump with power connected.

 **CAUTION!** Warns about hazards that can or will cause minor personal injury or property damage if ignored. Used with symbols below.

 **DO NOT** exceed manufacturers recommendation for maximum performance, as this could cause the motor to overheat.

 **DO NOT** remove cord and strain relief.

 **WARNING!** Cable should be protected at all times to avoid punctures, cut, fraying and abrasions. Inspect frequently. Never handle connected power cords with wet hands.

 **WARNING!** To reduce risk of electrical shock, all wiring and junction connections should be made per the NEC or CEC and applicable state or province and local codes. Requirements may vary depending on usage and location.

 **WARNING!** Products returned must be cleaned, sanitized, or decontaminated as necessarly prior to shipment. To insure that employees will not be exposed to health hazards in handling said material. All Applicable Laws And Regulations Shall Apply.

 **CAUTION!** Never operate a pump with a pump or equipment. Cranes Pumps & Systems, Inc. is not responsible for losses, injury, or death resulting from a failure to observe these safety precautions, misuse or abuse of pumps or equipment.

Other brand and product names are trademarks or registered trademarks of their respective holders. © Barnes is a registered trademark of Crane Pumps & Systems, Inc. Alteration Rights Reserved

DESCRIPTION: These self-priming transfer pumps are designed to easily transfer water from one point to another. Model BT12, 115 Volt Transfer Pump is great for household usage. Typical applications include removing water from waterbeds, clogged sinks, basements, etc. **NOTE: Do NOT use BT12 in pool areas. The motor model is non-submersible with overload protection.**

 **Always disconnect power source before attempting to install, service, or maintain the pump.** Never handle a pump with wet hands or when standing on wet damp surface or in water. Fatal electrical shock could occur.

 **Risk of electrical shock! This pump is supplied with a grounded conductor and grounding type attachment plug. A grounded receptacle in conformance with current NEC and local codes must be used (See Figure 1). Do NOT use in swimming pool areas.**

 **Risk of fatal electrical shock! Never cut off the round grounding prong. Cutting the cord or plug will void the warranty and make the pump inoperable.**

1. A ground fault circuit interrupter (GFCI) is required. Make sure lifting handles are securely fastened each time before lifting. **DO NOT** operate pump without safety devices in place. Always replace safety devices that have been removed during service or repair. Secure the pump in its operating position so it can not tip over, fall or slide.

DO NOT exceed manufacturers recommendation for maximum performance, as this could cause the motor to overheat.

WARNING! Cable should be protected at all times to avoid punctures, cut, fraying and abrasions. Inspect frequently. Never handle connected power cords with wet hands.

WARNING! To reduce risk of electrical shock, all wiring and junction connections should be made per the NEC or CEC and applicable state or province and local codes. Requirements may vary depending on usage and location.

WARNING! Submersible Pumps are not approved for use in swimming pools, recreational water installations decorative fountains or any installation where human contact with the pumped fluid is common.

WARNING! Products returned must be cleaned, sanitized, or decontaminated as necessarly prior to shipment. To insure that employees will not be exposed to health hazards in handling said material. All Applicable Laws And Regulations Shall Apply.

2. Examine the inlet and outlet hoses to insure there are no blockages, kinks or bends. The inlet hose should be no longer than 15 feet and the vertical pumping distance should not be any higher than 10 feet.

3. Connect pump to power source, with pump in a dry location. Plug into a 3-prong ground-type AC receptacle.

4. Do NOT operate the pump continuously above a discharge pressure of 28" as the motor will exceed safe operating temperature.

5. Examine the inlet and outlet hoses to insure there are no blockages, kinks or bends. The inlet hose should be no longer than 15 feet and the vertical pumping distance should not be any higher than 10 feet.

6. Remove the four cover plate screws holding motor housing and pump housing together. Cover plate is now free and can be removed.

7. Inspect gasket and impeller for wear and damage. If there is any evidence of wear or damages, replace the part(s).

8. Lubricate new impeller with white grease or lightweight oil and reinstall by aligning flat on impeller hub with flat on motor shaft.

9. Reassemble gasket, cover plate, and cover plate screws.

SHAFT SEAL REPLACEMENT

Motor shafts are sealed with factory pre-lubricated lip-type seals which are good for the life of the pump. If the seal leaks, it is usually because the pump has handled abrasive liquids. If the motor shaft is scored (deep grooves), the complete pump must be replaced.

1. Remove and inspect impeller parts as specified in the impeller replacement instructions. Replace worn parts.

2. Remove two pump body mounting screws and slide pump body from motor. Pry out seal retaining ring and push worn shaft seal from inside of pump body.

3. Lubricate new seal with lightweight oil, push it into pump body with lip facing away from motor, and push in seal retaining ring.

4. Reassemble pump body onto motor with mounting screws. Follow steps 3 and 4 in **IMPELLER REPLACEMENT.**

MOTOR BRUSH REPLACEMENT

Brushes for this pump should be inspected after 75 hours of operation and replaced if worn. They must be replaced every 150 hour of operation. Service one brush at a time.

1. Disconnect pump from power supply.

2. Remove brush caps with screwdriver.

3. Remove old brush assembly.

4. Insert new brush assembly.

5. Replace brush caps

6. Pump operation will be seriously hindered or prevented if the inlet hose is over 15 feet long or if the vertical pumping distance exceeds 10 feet.

7. At times, an overload due to over heating, low voltage, jammed impeller, etc. may shut the pump off. Unplug or turn off the pump and wait at lease ten minutes. The pump will cool and automatically reset.

8. Motor should never be operated for more than 2 hours continuously. Critical heating can occur and might severely damage the pump and void warranty.

9. Pump operation will be seriously hindered or prevented if the inlet hose is over 15 feet long or if the vertical pumping distance exceeds 10 feet.

10. Pump should never be operated for more than 2 hours continuously. Critical heating can occur and might severely damage the pump and void warranty.

11. Add 1 tablespoon of vegetable oil to both inlet and outlet to prime.

12. Attach included 6' suction hose to inlet of pump. Attach garden hose to outlet of pump. There must be a gasket in place to insure that these connections are airtight, otherwise the pump will not prime. Connect water suction attachment to the open end of inlet hose and place below water surface. (Water suction attachment is optional). The water suction attachment is designed to fit the male end of a garden hose. Place the water suction attachment as near as possible to the middle of the water that is to be pumped.

OPERATION:

1. Add 1 tablespoon of vegetable oil to both inlet and outlet to prime.

2. Attach included 6' suction hose to inlet of pump. Attach garden hose to outlet of pump. There must be a gasket in place to insure that these connections are airtight, otherwise the pump will not prime. Connect water suction attachment to the open end of inlet hose and place below water surface. (Water suction attachment is optional). The water suction attachment is designed to fit the male end of a garden hose. Place the water suction attachment as near as possible to the middle of the water that is to be pumped.

INSTALLATION: Model BT12 includes a 6' suction hose, a water suction attachment, and a replacement part kit which includes: impeller, gasket, shaft seal, and two motor brushes. Model BT2 can be used without the water suction attachment.

WARNING! Do not wear loose clothing that may become entangled in moving parts.

WARNING! Keep clear of suction and discharge openings. **DO NOT** insert fingers in pump with power connected.

CAUTION! Warns about hazards that can or will cause minor personal injury or property damage if ignored. Used with symbols below.

CAUTION! Warns about hazards that can or will cause serious personal injury, death, or major property damage if ignored. Used with symbols below.

DO NOT remove cord and strain relief.

WARNING! Cable should be protected at all times to avoid punctures, cut, fraying and abrasions. Inspect frequently. Never handle connected power cords with wet hands.

WARNING! Products returned must be cleaned, sanitized, or decontaminated as necessarly prior to shipment. To insure that employees will not be exposed to health hazards in handling said material. All Applicable Laws And Regulations Shall Apply.

WARNING! To reduce risk of electrical shock, pumps and control panels must be properly grounded in accordance with the National Electric Code (NEC) or the Canadian Electrical Code (CEC) and all applicable state, province, local codes and ordinances. Improper grounding voids warranty.

WARNING! Operation against a closed discharge valve will cause premature bearing and seal failure on any pump, and on end suction and self priming pump the heat build up may cause the generation of steam with resulting dangerous pressures. It is recommended that a high case temperature relief valve be installed on the pump body.

CAUTION! Never operate a pump with a plug-in type power cord without a ground fault circuit interrupter.

CAUTION! Pumps built up heat and pressure during operation - allow time for pumps to cool before handling or servicing.

WARNING! Do not pump hazardous materials (flammable, caustic, etc.) unless the pump is specifically designed and designated to handle them.

Other brand and product names are trademarks or registered trademarks of their respective holders. © Barnes is a registered trademark of Crane Pumps & Systems, Inc. Alteration Rights Reserved

Item No.	Qty.	Description
A	1	Impeller
B	2	Gasket
C	1	Shaft Seal
D	1	Retaining Ring
E	2	Brushes
F	1	Water Suction Attachment
G	1	6ft. Suction Hose

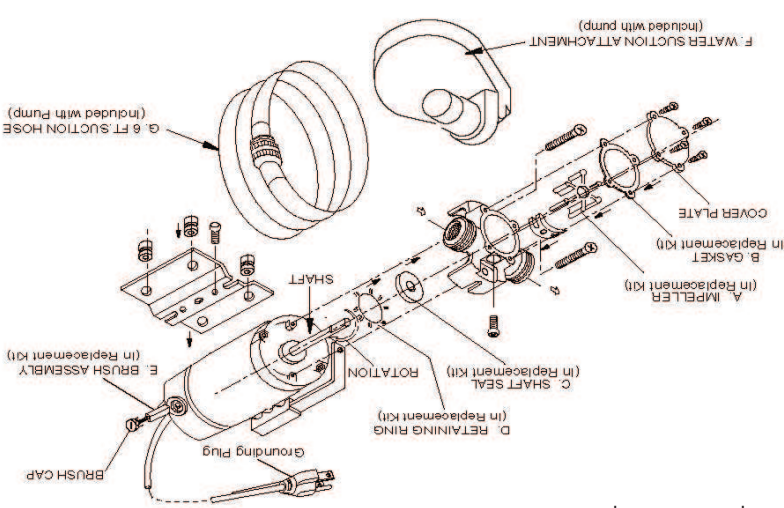

1. Examine the inlet and outlet hoses to insure there are no blockages, kinks or bends. The inlet hose should be no longer than 15 feet and the vertical pumping distance should not be any higher than 10 feet.

2. Connect pump to power source, with pump in a dry location. Plug into a 3-prong ground-type AC receptacle.

3. Do NOT operate the pump continuously above a discharge pressure of 28" as the motor will exceed safe operating temperature.

4. Examine the inlet and outlet hoses to insure there are no blockages, kinks or bends. The inlet hose should be no longer than 15 feet and the vertical pumping distance should not be any higher than 10 feet.

5. Remove the four cover plate screws holding motor housing and pump housing together. Cover plate is now free and can be removed.

6. Inspect gasket and impeller for wear and damage. If there is any evidence of wear or damages, replace the part(s).

7. Lubricate new impeller with white grease or lightweight oil and reinstall by aligning flat on impeller hub with flat on motor shaft.

8. Reassemble gasket, cover plate, and cover plate screws.

SHAFT SEAL REPLACEMENT

Motor shafts are sealed with factory pre-lubricated lip-type seals which are good for the life of the pump. If the seal leaks, it is usually because the pump has handled abrasive liquids. If the motor shaft is scored (deep grooves), the complete pump must be replaced.

1. Remove and inspect impeller parts as specified in the impeller replacement instructions. Replace worn parts.

2. Remove two pump body mounting screws and slide pump body from motor. Pry out seal retaining ring and push worn shaft seal from inside of pump body.

3. Lubricate new seal with lightweight oil, push it into pump body with lip facing away from motor, and push in seal retaining ring.

4. Reassemble pump body onto motor with mounting screws. Follow steps 3 and 4 in **IMPELLER REPLACEMENT.**

MOTOR BRUSH REPLACEMENT

Brushes for this pump should be inspected after 75 hours of operation and replaced if worn. They must be replaced every 150 hour of operation. Service one brush at a time.

1. Disconnect pump from power supply.

2. Remove brush caps with screwdriver.

3. Remove old brush assembly.

4. Insert new brush assembly.

5. Replace brush caps

6. Pump operation will be seriously hindered or prevented if the inlet hose is over 15 feet long or if the vertical pumping distance exceeds 10 feet.

7. At times, an overload due to over heating, low voltage, jammed impeller, etc. may shut the pump off. Unplug or turn off the pump and wait at lease ten minutes. The pump will cool and automatically reset.

8. Motor should never be operated for more than 2 hours continuously. Critical heating can occur and might severely damage the pump and void warranty.

9. Pump operation will be seriously hindered or prevented if the inlet hose is over 15 feet long or if the vertical pumping distance exceeds 10 feet.

10. Pump should never be operated for more than 2 hours continuously. Critical heating can occur and might severely damage the pump and void warranty.

11. Add 1 tablespoon of vegetable oil to both inlet and outlet to prime.

12. Attach included 6' suction hose to inlet of pump. Attach garden hose to outlet of pump. There must be a gasket in place to insure that these connections are airtight, otherwise the pump will not prime. Connect water suction attachment to the open end of inlet hose and place below water surface. (Water suction attachment is optional). The water suction attachment is designed to fit the male end of a garden hose. Place the water suction attachment as near as possible to the middle of the water that is to be pumped.

OPERATION:

1. Add 1 tablespoon of vegetable oil to both inlet and outlet to prime.

2. Attach included 6' suction hose to inlet of pump. Attach garden hose to outlet of pump. There must be a gasket in place to insure that these connections are airtight, otherwise the pump will not prime. Connect water suction attachment to the open end of inlet hose and place below water surface. (Water suction attachment is optional). The water suction attachment is designed to fit the male end of a garden hose. Place the water suction attachment as near as possible to the middle of the water that is to be pumped.

INSTALLATION: Model BT12 includes a 6' suction hose, a water suction attachment, and a replacement part kit which includes: impeller, gasket, shaft seal, and two motor brushes. Model BT2 can be used without the water suction attachment.

WARNING! Do not wear loose clothing that may become entangled in moving parts.

WARNING! Keep clear of suction and discharge openings. **DO NOT** insert fingers in pump with power connected.

CAUTION! Warns about hazards that can or will cause minor personal injury or property damage if ignored. Used with symbols below.

CAUTION! Warns about hazards that can or will cause serious personal injury, death, or major property damage if ignored. Used with symbols below.

DO NOT remove cord and strain relief.

WARNING! Cable should be protected at all times to avoid punctures, cut, fraying and abrasions. Inspect frequently. Never handle connected power cords with wet hands.

WARNING! Products returned must be cleaned, sanitized, or decontaminated as necessarly prior to shipment. To insure that employees will not be exposed to health hazards in handling said material. All Applicable Laws And Regulations Shall Apply.

WARNING! To reduce risk of electrical shock, pumps and control panels must be properly grounded in accordance with the National Electric Code (NEC) or the Canadian Electrical Code (CEC) and all applicable state, province, local codes and ordinances. Improper grounding voids warranty.

WARNING! Operation against a closed discharge valve will cause premature bearing and seal failure on any pump, and on end suction and self priming pump the heat build up may cause the generation of steam with resulting dangerous pressures. It is recommended that a high case temperature relief valve be installed on the pump body.

CAUTION! Never operate a pump with a plug-in type power cord without a ground fault circuit interrupter.

CAUTION! Pumps built up heat and pressure during operation - allow time for pumps to cool before handling or servicing.

WARNING! Do not pump hazardous materials (flammable, caustic, etc.) unless the pump is specifically designed and designated to handle them.

Other brand and product names are trademarks or registered trademarks of their respective holders. © Barnes is a registered trademark of Crane Pumps & Systems, Inc. Alteration Rights Reserved

TROUBLE SHOOTING

CAUTION! Always disconnect the pump from the electrical power source before handling. If the system fails to operate properly, carefully read instructions and perform maintenance recommendations. If operating problems persist, the following chart may be of assistance in identifying and correcting them. **MATCH "CAUSE" NUMBER WITH "CORRECTING" NUMBER.**

NOTE: Not all problems and corrections will apply to each pump model.

PROBLEM	CAUSE	CORRECTION
Pump will not run	1. Poor electrical connection, blown fuse, tripped breaker or other interruption of power, improper power supply. Check for blown fuses, security. Check connection, blown fuse, all electrical connections for tripped breaker or other interruption of power, security. Check for blown fuses, tripped circuit breakers or tripped GFCI outlets.	1. Check electrical connection, blown fuse, tripped breaker or other interruption of power, security. Check for blown fuses, tripped circuit breakers or tripped GFCI outlets.
Pump will not turn off	2. Switch will not activate pump or is defective.	2. Reposition pump or clean pump/basin
Pump hums but does not run	1. Incorrect voltage or damaged, inlet plugged.	3. Make sure liquid level is at least equal to suggested turn-on point.
Pump delivers insufficient capacity	1. Excessive inflow or sizing calculations to determine proper pump size.	4. Recheck all calculations to determine proper pump size.
Pump cycles too frequently or runs periodically backwards.	6. Check valve stuck closed or installed backwards.	4. Recheck all calculations to determine proper pump size.
Pump shuts off and turns on independently of pump not properly sized	1. Incorrect voltage, excessive inflow or and turns on independently of pump not properly sized	4. Recheck all calculations to determine proper pump size.
Pump operates noisily or excessively	5. Discharge restricted building structure too rigid or too loose.	4. Recheck all calculations to determine proper pump size.