

EDGESTAR[®]

Built-In Kegerator

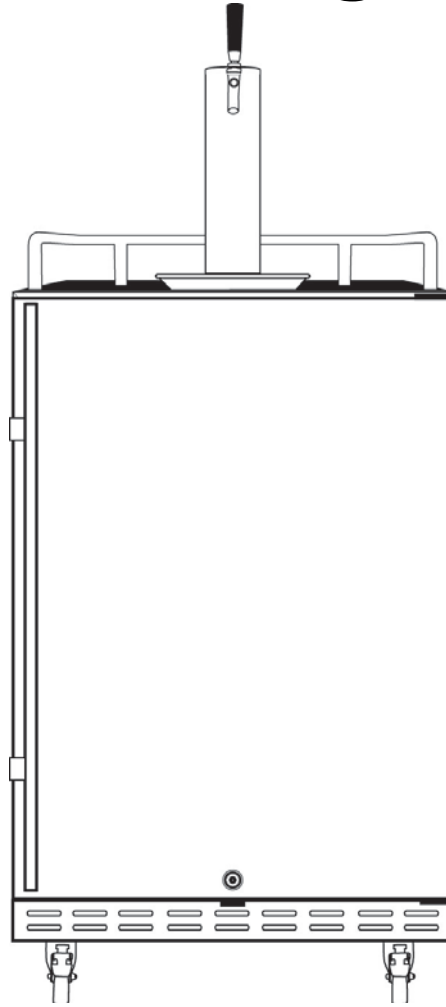

BR7001SS / BR7001SSOD BR7001BL

Refrigerators for the KC7000 Series of Kegerators

Owner's Manual

For more information on other great EdgeStar products on the web, go to <https://www.edgestar.com>
To use the EdgeStar self-diagnostic tool, go to <https://support.edgestar.com>

Important Safety Information

Improper handling can cause serious damage to the EdgeStar kegerator and/or injury to the user. This kegerator is designed for domestic use only. **Do not use the unit for industrial or commercial use.** Any other use may invalidate the warranty. Please review the ratings label located on the rear panel of the unit for electrical and other technical data related to this unit. The unit must be used in a properly grounded wall outlet.

Please read and follow the safety information listed below to reduce the risk of fire, electric shock, or injury.



Electrical Safety

- Do not exceed the power outlet ratings.
- It is recommended that the kegerator be connected on its own circuit.
- The unit must be installed in accordance with state and local electrical codes.
- A standard electrical supply (115 V, 60 Hz), that is properly grounded in accordance with the National Electrical Code and local codes and ordinances is required.
- Use outlets that cannot be turned off by a switch or pull chain.
- Always turn the unit off and unplug it from the outlet when cleaning.
- Unplug the unit if it is not going to be used for an extended period of time.
- Do not operate the unit with a power plug missing the ground plug, a damaged cord, or a loose socket.
- Be sure the kegerator is properly grounded.
- Never plug or unplug the unit with wet hands.
- Do not bypass, cut, or remove the grounding plug.
- Do not use extension cords or power strips with this unit. You may need to contact your electrician if it is necessary to use a longer cord or if you do not have a grounded outlet. Do not modify the power cord's length or share the outlet with other appliances.
- Do not start or stop the unit by switching the circuit's power on and off.
- If the power cord is damaged, it must be replaced by the manufacturer or a qualified technician.
- Never repair the unit while it is plugged in.
- Immediately unplug the unit if it makes strange sounds, emits smells, or smoke comes out of it, and contact customer service.
- Do not remove any part of the casing unless instructed to do so by an authorized technician.
- You should never attempt to repair the unit yourself.
- Contact customer service for service options if the unit needs service.



Note: Flammable Refrigerant Used! When handling, moving, and using the refrigerator: make sure to avoid either damaging the refrigerant tubing, or increasing the risk of a leak.



General Safety

- To prevent back and other types of injuries, use at least two people to move and install the kegerator.
- This unit is not intended for use by persons, including children, with reduced physical, sensory, or mental capabilities, unless they have been given supervision or instruction concerning the use of the appliance by the person(s) responsible for their safety.
- Install the unit in a well-ventilated area where the ambient temperature is above 50°F and below 95°F.
- The temperature range for this kegerator is optimized for beverage storage. Perishable food items may require a different storage environment.
- Do not place hot or warm items into the kegerator before they cool down to room temperature.
- This unit is designed to be installed indoors (except for the BR7001SSOD), and protected from rain, sleet, snow and/or moisture (all units).
- This unit is not intended to be used by children.
- Children should be supervised to ensure that they do not play with this product.
- Never allow children to crawl inside the kegerator. If disposing of the unit, remove the door.
- Do not use this unit near flammable gas or combustibles, such as gasoline, benzene, thinner, etc.
- Do not place the unit near heat sources such as ovens, grills, or direct sunlight.
- Only use in an upright position on a flat, level surface and provide proper ventilation.
- Do not pinch or kink the power supply line between the unit and cabinet.
- Do not leave any cleaning solutions in the unit.
- Do not use solvent-based cleaning agents or abrasive solutions to clean the unit as they may damage the interior and exterior.
- Do not place any other appliances on top of the unit.
- Do not turn the unit upside down, on its side, or at an angle off level.
- If your model is equipped with a lock, take care to keep the keys away from children.
- Do not move the unit without emptying the contents and securing the door in a closed position.



Note: This owner's manual is provided for reference use only. Specifications may change without prior notice. Refer to the product label on the back of your kegerator for the latest technical information.

Table of Contents

- IMPORTANT SAFETY INFORMATION.....I**
- TABLE OF CONTENTS.....3**
- INTRODUCTION.....4**
- PARTS IDENTIFICATION.....5**
- FRONT VIEW.....5*
- BACK VIEW.....5*
- ACCESSORIES.....6**
- STANDARD ACCESSORIES.....6*
- INSTALLING THE KEGERATOR.....6**
- ELECTRICAL REQUIREMENTS.....7*
- Recommended Grounding Method.....8*
- LEVELING THE KEGERATOR.....8*
- INSTALLING THE STAINLESS STEEL DOOR HANDLE.....8*
- INSTALLING THE CASTERS.....9*
- REVERSING THE DOOR SWING.....9*
- FREE STANDING INSTALLATION.....11*
- Guard Rail.....11*
- Drip Tray.....11*
- BUILT-IN INSTALLATION.....12*
- Countertop Opening for Dispense Kit.....12*
- Installation Requirements.....13*
- Enclose Space Between Cabinet and Countertop.....14*
- KEG LOADING.....15**
- OPERATION.....16**
- INSTALLATION CHECK LIST BEFORE OPERATION.....16*
- USING THE TEMPERATURE CONTROL PANELS.....16*
- NORMAL SOUNDS.....17*
- DEFROSTING.....17*
- PREPARING THE KEGERATOR FOR STORAGE.....17*
- CLEANING AND MAINTENANCE.....18**
- EXTERIOR CLEANING.....18*
- INTERIOR CLEANING.....18*
- TROUBLESHOOTING.....18**
- SPECIFICATIONS.....20**
- EDGE STAR LIMITED WARRANTY.....21**

First Time Operating Instructions

Before use, make sure all packaging labels and materials are all removed from the unit. Be sure to keep track of all included parts and pieces before discarding packaging materials. It is advised that you keep the original box and packaging materials in case you are ever to move or ship the appliance in the future.

Let the unit stand for at least 24 hours before you use it; this allows the cooling components time to settle from transit. The instruction manual should be read before use.

Introduction

Thank you for purchasing this EdgeStar kegerator. We hope that this purchase will be the beginning of a lasting and rewarding relationship between you and EdgeStar. We will provide the customer support and exemplary products necessary to nurture that relationship.

This manual contains important information regarding the proper installation, use and maintenance of your kegerator. Following this manual will ensure that your product will work at its peak performance and efficiency.

Please save the original product packaging in case you need to safely transport your kegerator.

For Your Records:

Please write down the model number and serial number below for future reference.

Both numbers are located on the ratings label on the back of your unit and are needed to obtain warranty service. You may also want to staple your receipt to this manual as it is the proof of your purchase, and is also needed for service under your warranty.

Model Number: _____

Serial Number: _____

Date of Purchase: _____

For a more efficient experience, please do the following before contacting customer service:

- If you received a damaged product, immediately contact the retailer or dealer that sold you the product.
- Read and follow this instruction manual carefully to help you install, use, and maintain your kegerator.
- Read the troubleshooting section of this manual as it will help you diagnose and solve common issues.
- Visit us on the web at <https://www.edgestar.com> to register your product, download product guides, additional troubleshooting resources, and up-to-date information. You can also find an interactive self-diagnostic tool at <https://support.edgestar.com>
- If you need warranty service, our friendly customer service representatives are available via email at **service@edgestar.com** or by telephone at **1 (866) 319-5473**.

Parts Identification



Tip: Gather the model and serial number from the product label and write them down before installing the kegerator.

Front View

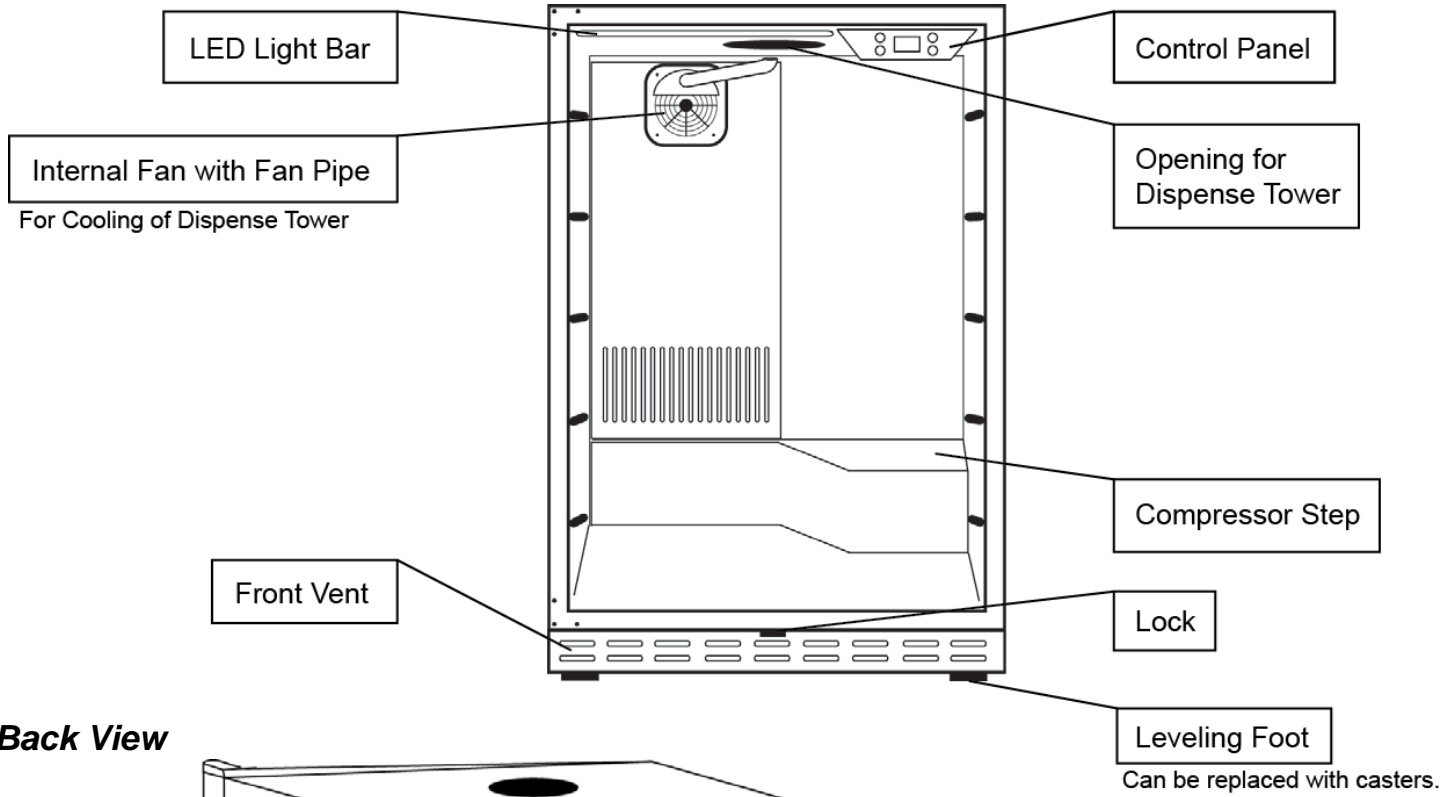

Back View

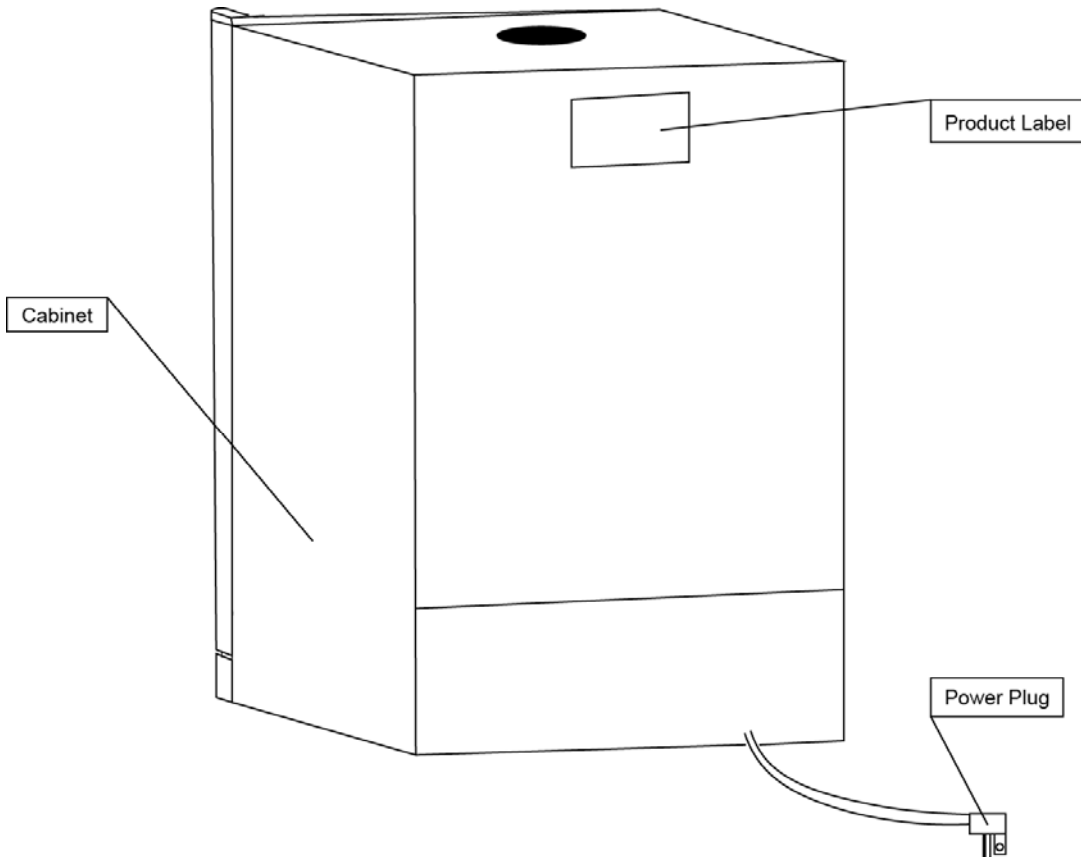

Accessories

Your kegerator will come with a set of standard accessories. These include a drip tray, guard rail, guard rail installation pegs, door handle, casters, and dispense tower screws. The other equipment / accessories you receive for the dispense kit and CO2 tank will be based upon the type of kegerator you purchased.

Standard Accessories

(1) Drip Tray



(1) Guard Rail

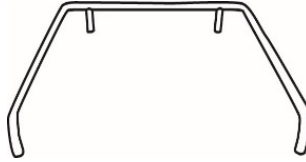

(4) Guard Rail Installation Pegs



(1) Door Handle
(Not included with BR7001BL)



(4) Casters
(Includes 16 screws for installation)



(4) Dispense Tower Screws
(For attaching dispense tower to cabinet)

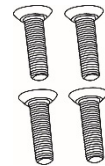

Note: The variation of kegerator you purchase will determine the type of accessories you will receive for the dispense kit. The most common options include single, dual, and triple taps.

Installing the Kegerator

The kegerator should be installed in accordance with local electrical code requirements. The

kegerator should also be placed in a location that is strong enough to support its total weight, keeping in mind that it will weigh substantially more when fully loaded than when empty.

Before you plug the kegerator into a power supply, be sure to let it stand upright for at least 24 hours to allow the compressor's oils to settle.

Unpacking the Kegerator



Warning: Use two or more people to move and install the kegerator. Failure to do so can result in back or other injury.

Carefully remove the packaging materials. Remove any shipping tape and glue from your kegerator before using. Do not use sharp instruments, rubbing alcohol, flammable fluids, or abrasive cleaners to remove tape or glue. These products can damage the surface of your kegerator.



Important: Do not remove any safety, warning, or product information labels from your kegerator.

Electrical Requirements



ELECTRIC SHOCK HAZARD!

- Plug into a grounded 3-prong outlet.
- Never remove the grounding prong from the plug.
- Never use an adapter to bypass the grounding prong.
- DO NOT use an extension cord.
- Failure to follow these instructions can result in fire, electrical shock, or death.

Before you move your kegerator into its final location, it is important to make sure you have the proper electrical connection:

A standard electrical supply (115 V, 60Hz), properly grounded in accordance with the National Electrical Code and local codes and ordinances, is required.

It is recommended that a separate circuit, serving only your kegerator, be provided. Use receptacles that cannot be turned off by a switch or pull chain.

The fuse (or circuit breaker) size should be 10 Amps or greater.

Recommended Grounding Method

For your personal safety, this appliance must be grounded. It is equipped with a power supply cord having a 3-prong grounding plug. To minimize possible shock hazard, the cord must be plugged into a mating 3-pronged wall socket, and grounded in accordance with the National Electrical Code and local codes and ordinances. If a mating wall socket is not available, it is the personal responsibility of the customer to have a properly grounded, 3-prong wall receptacle installed by a qualified electrician.

Leveling the Kegerator

It is important for the kegerator to be leveled in order to work properly. It can be raised or lowered by rotating the plastic sheaths around each of the feet on the bottom of the machine. If you find that the surface is not level, rotate the feet until the kegerator becomes level. You may need to make several adjustments to level it. We recommend using a carpenter's level to check the machine.

1. Place a carpenter's level on top of the product to see if the kegerator is level from front to back and side to side.
2. Adjust the height of the feet as follows:
Turn the leveling feet to the right to lower that side of the kegerator.
Turn the leveling feet to the left to raise that side of the kegerator.

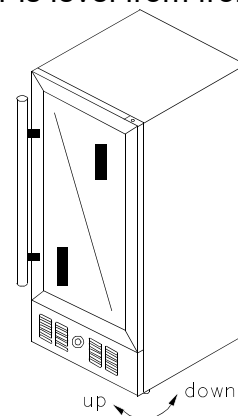

Important: Once you are ready to install it in a cabinet or directly on the floor, you must adjust the feet to level the kegerator.

Installing the Stainless Steel Door Handle

BR7001SS, BR7001SSOD models only

To install a door handle:

1. Remove the four screws from the side of the door. This should be the side opposite of the door hinge.
2. Place and align the openings of the handle hinges over the screw holes in the side of the door.
3. Insert and tighten the screws to hold the handle in place.

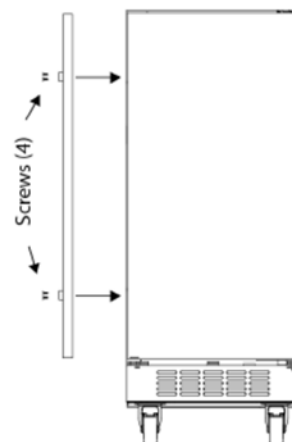



Caution: Do not over-tighten the screws as this may cause damage to the handle or to the stainless steel door.

Installing the Casters

This unit comes with four (4) casters. These are an optional accessory to assemble if you would like to make the unit more mobile. To install the casters:

1. Remove the four leveling legs from the bottom of the unit.
2. Separate the front casters and back casters. The front casters have a lever for a brake lock.
3. Place the top plate of the caster over the area of the removed leveling leg and align the opening to the screw hole openings.
4. Insert the screws to attach the caster to the cabinet.
5. Make sure the screws are tight so the caster is installed firmly.

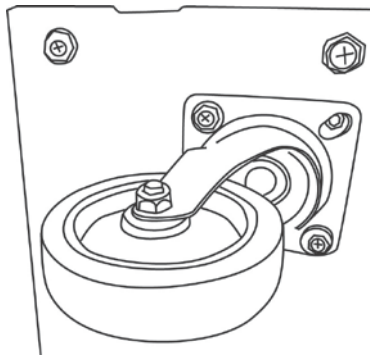

Reversing the Door Swing



Important: Before you begin, unplug the refrigerator.

Follow the instructions below to reverse the door swing.

To reverse the door from right swing to left swing:

1. Open the door and, using a Phillips screwdriver, remove the bottom screws from the lower hinge.

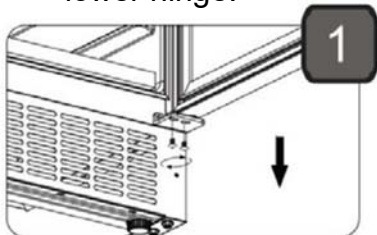

- Carefully slide the bottom of the door forward and down, and place it on a padded surface to prevent damaging it.

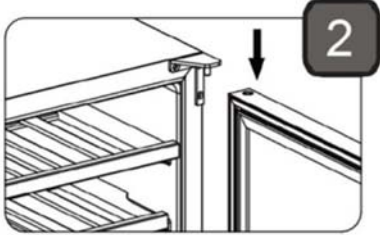

- Remove the screws from the upper right hinge. Place the upper right hinge in a safe place in case you need to reverse the door in the future. Remove the plastic caps from the upper left hinge corner. Install the upper left hinge by fastening the screws through the left hinge to the cabinet. Insert the plastic caps into the upper right corner.

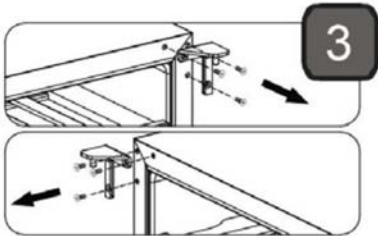

- Remove the bottom right support bracket. Remove the plastic caps from the bottom left hinge corner. Insert the plastic caps into the bottom right corner. Install the bottom left support bracket from the plastic bag that was included with the instruction manual.

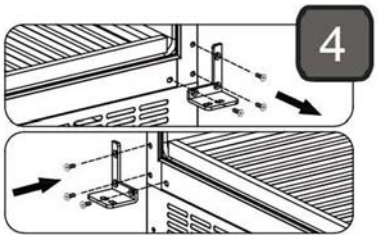

- Carefully insert the door into the upper left corner hinge. Install the lower hinge on the left corner of the door.

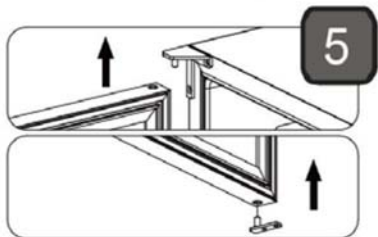

- Slide the door on top of the lower hinge and secure the door by installing the lower screws.

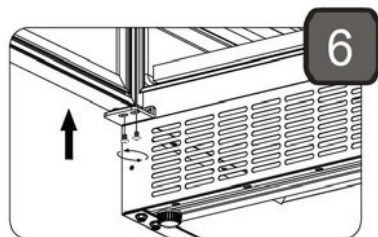

Free Standing Installation



Note: Please refer to the dispense kit installation guide to complete the full assembly of the kegerator.

A free standing installation will allow you to install the kegerator in almost any place you desire. Please follow the safety information referenced on the “Important Safety Information” page in this manual.

Guard Rail

The guard rail helps to hold glasses on the top of the cabinet in order to avoid spills or broken glass.

1. Insert the four installation pegs on the outer edges of the top of the cabinet.
2. Place the guard rail onto the four installation pegs. You may need to push down on the guard rail to ensure the rail has clicked into place on the pegs.
3. Screw the four small guard rail screws into the guard rail. This will lock the rail into position.

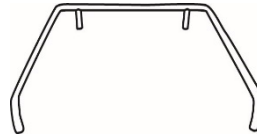

Drip Tray

The surface mount drip tray is a reservoir designed to collect any runoff liquid from overfilled glasses, leaking faucets, or spills. There are two pieces included for this tray. Place it on top of the cabinet (or countertop) and position under the faucet(s).

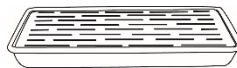

Built-in Installation



Note: Please refer to the dispense kit installation guide to complete the full assembly of the kegerator.

A built-in installation allows the kegerator to be placed under counter. This installation requires several more steps and considerations than a free standing installation.

Countertop Opening for Dispense Kit



Important Notes:

- Choose a location that has ambient temperatures above 50°F and below 95°F. Operation outside these temperatures may result in lowered efficiency or cause other adverse effects.
- This unit **MUST** be installed in an area protected from the elements, e.g., wind, rain, water spray, or drips.
- The kegerator should not be located next to ovens, grills, or other high heat sources.
- Do not kink or pinch the power supply cord between the kegerator and the wall or cabinet.

Once the location of the kegerator installation is determined the first step is to create an opening in the counter for the dispense kit lines to pass through. Mark off a spot on the countertop where the opening will be created. Align that spot so it will be directly above the opening of the kegerator that will be placed under the counter. You will need to drill or cut (depending on the material of your countertop) an opening into your counter the same size as the opening of the top of the kegerator. Do not cut it larger than that size as the dispense tower will be optimized for that size hole.

Installation Requirements

Once an opening is created in the countertop the next step is to install the cabinet. When installing the kegerator under a counter, follow the recommended spacing dimensions shown below.

- Make sure the top cover, guard rail, drip tray, and installation pegs are NOT installed on the top of the cabinet. These items will create an obstacle for the cabinet to be installed under counter.
- Move the kegerator so the opening on the top of the cabinet is aligned with the opening in the counter.
- The kegerator should be installed on a firm and level surface that will be able to support the entire weight of a fully loaded unit. It is important for the kegerator to be level in order to work properly. If needed, you can adjust the height of the kegerator by rotating the feet. See the “Leveling the Kegerator” section.
- A standard electrical supply (115 VAC only, 60 Hz), properly grounded in accordance with National Electrical Code and local codes and ordinances is required.

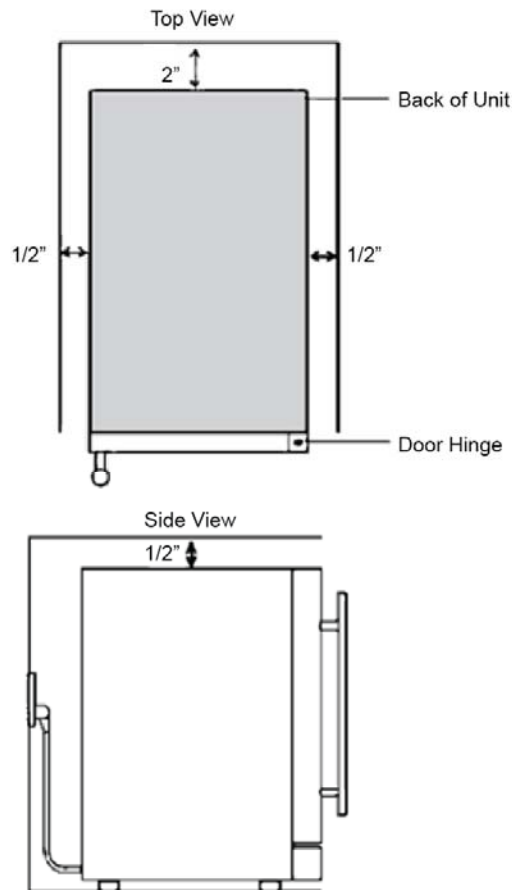

Enclose Space Between Cabinet and Countertop

Once the cabinet is installed and the two openings of the cabinet and countertop are aligned, you must seal off the open space that will be created above the kegerator cabinet and under the countertop. If this open space is not properly sealed, the cabinet will lose its cold air and allow warm air to enter. Similarly to leaving the kegerator door open, an improper seal can result in kegerator performance issues such as temperature inconsistency, foam problems, and excessive frost build up in certain cases.

To close the opening you will need to run a short connecting tube from the cabinet to the countertop. There is not an accessory included for this connection with the unit. Common materials for this connection include PVC pipe, insulated pipe tubing, or rubber lining material. It is important to form a seal between the kegerator cabinet opening and the bottom surface of the countertop. If you use PVC or foam tubing, your sealing apparatus may extend from the interior of the kegerator cabinet up through the countertop and into the base of the faucet tower.



Note: This installation tip applies to front vented, built-in capable kegerator models only. Improper installation of a kegerator that is not intended for a built in application will result in damage to your appliance.

Correct Installation

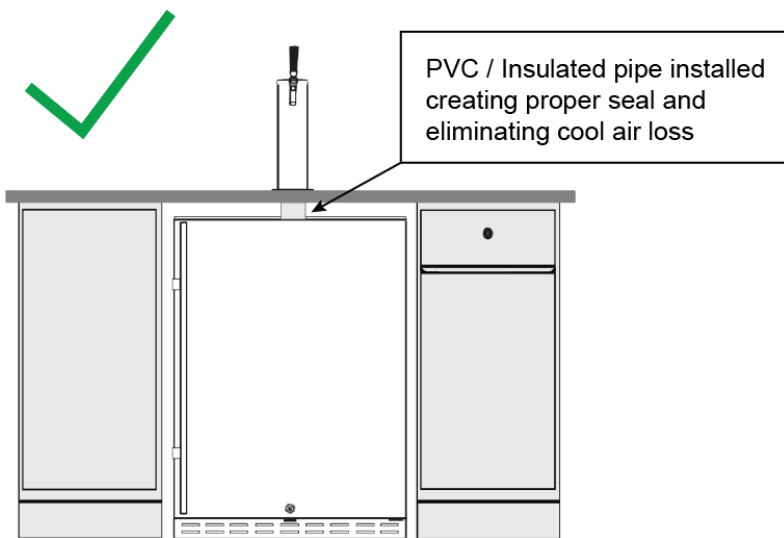

Incorrect Installation

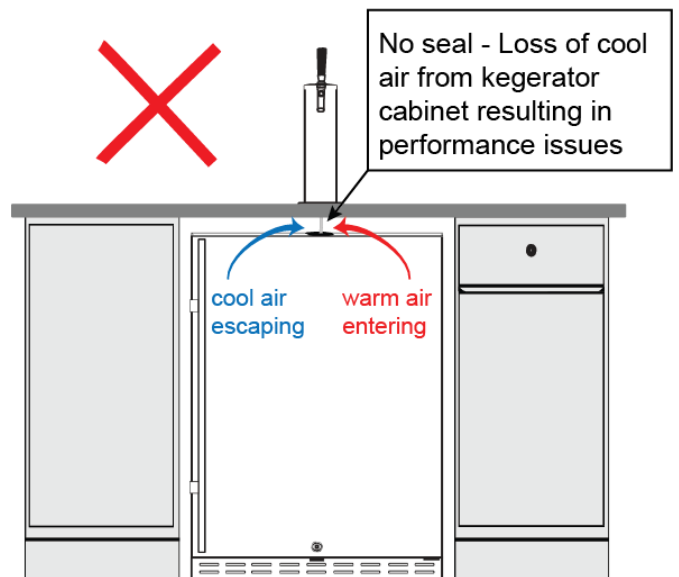

Keg Loading

- Half Barrel Keg
- 5 lb. CO2 tank
- Double Gauge Regulator

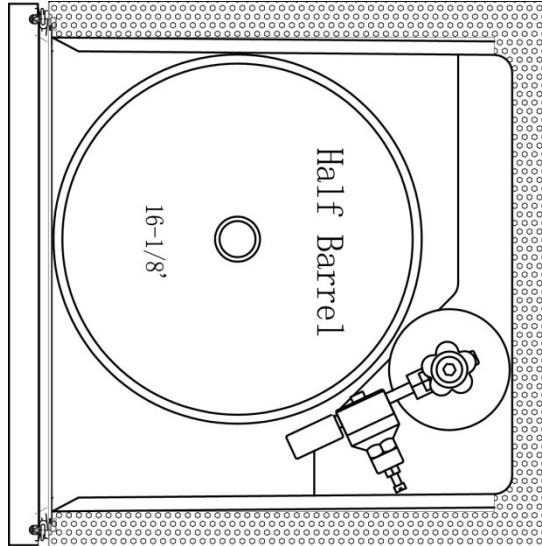

- Slim Quarter Keg
- Sixth Barrel Keg
- 5 lb. CO2 tank
- Double Gauge Regulator

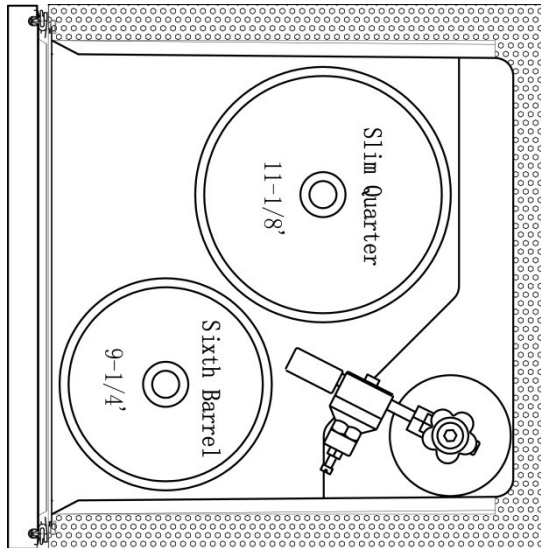

- Three Sixth Barrel Kegs
- 5 lb. CO2 tank
- Double Gauge Regulator

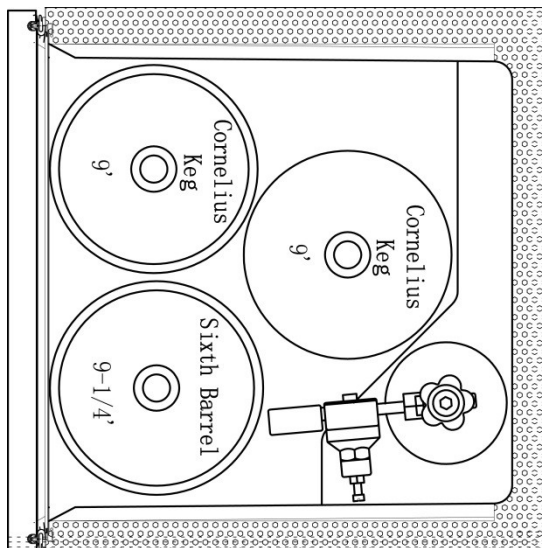

Operation

Installation Check List Before Operation

1. Have all packing materials and tape been removed from the interior and exterior of the kegerator?
2. Have the installation instructions been followed, including connecting the machine to electricity? And has proper grounding been installed for the kegerator?
3. Has the machine been leveled?
4. Is the kegerator in a site where the ambient temperature is between 50°F and 95°F all year round?

Using the Temperature Control Panels



Caution: If you power off the unit, please wait at least 5 minutes before powering it back on.

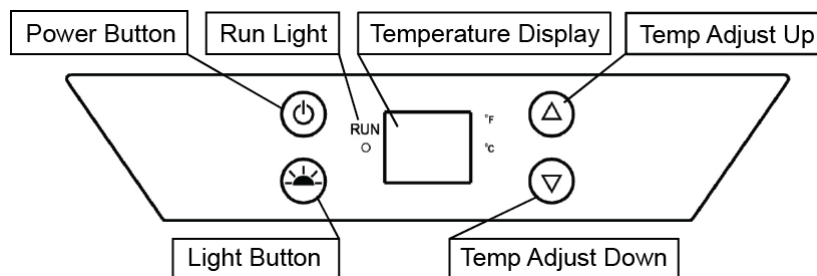

Use the up and down buttons to adjust the temperature. The temperature displayed can be in Fahrenheit or Celsius. This kegerator has a temperature range from 32°F to 60°F.

This kegerator has one display. The unit will display the set temperature only. The kegerator also has a memory function that allows the unit to revert back to the most recent set temperature in the event of a power outage, or if the unit is manually powered off and back on.

Press the ▼ button on the control panel to lower the temperature by a 1 degree increments.

Press the ▲ button on the control panel to increase the temperature by a 1 degree increments.

Press the  button to turn the inner light on or off.

Press and hold the power button for approximately three (3) seconds to turn the unit's power on or off. The Run Light will illuminate when the unit is working.

The Celsius or Fahrenheit light will be lit depending on what scale temperature is being displayed. To switch between C and F, press and hold the ▼ and ▲ buttons at the same time for approximately five (5) seconds until the temperature scale changes.



Note: Whether your kegerator can reach the actual set temperature depends on the ambient environmental conditions.

Normal Sounds

Your new kegerator may make sounds that are not familiar to you. Most of the new sounds are normal. Hard surfaces like the floor and walls can make the sounds seem louder than they actually are. The following describes the kinds of sounds that might be new to you and what may be making them.

- Rattling noises may come from the flow of the refrigerant or the water line. Items stored on top of the kegerator can also make noises.
- The high efficiency compressor may make a pulsating or high-pitched sound.
- Water running from the evaporator to the water bin may make a splashing sound.
- As each cycle ends, you may hear a gurgling sound due to the refrigerant flowing in your kegerator.
- You may hear air being forced over the condenser by the condenser fan.

Defrosting

Note that under most refrigerating settings, the unit will automatically defrost under most ambient conditions. However, on colder settings, some frost may build up. Additionally, the more humid the ambient conditions, the more frost may build up. Keep the door closed as much as possible and avoid opening the door unnecessarily to minimize frost build-up.

If frost is preventing the door from closing properly, you may need to power the unit off until the frost melts. Use a soft absorbent towel to dry the unit.



Warning: Never attempt to remove frost with a sharp object!

Preparing the Kegerator for Storage

If the kegerator will not be used for a long time, or is to be moved to another place, it will be necessary to defrost the unit and dry the interior.

1. Disconnect the unit from the power supply by removing the power plug from the wall socket.
2. Leave the door open to allow for air circulation and to prevent mold, mildew, and unpleasant smells.



Caution: Store the unit out of the reach of children. If you have children, you may want to take additional precautions such as removing the doors to prevent a child from being trapped inside the unit!



Important:

- Do not touch the power plug when your hands are wet.
- Never unplug the unit by pulling on the plug.

Cleaning and Maintenance

Periodic cleaning and proper maintenance will ensure efficiency, top performance, and long life.

Exterior Cleaning

The door and cabinet may be cleaned with a mild detergent and lukewarm water solution such as 2 tablespoons of baking soda to 1 quart of water.

Do not use solvent based or abrasive cleaners. Use a soft sponge and rinse with clean water. Wipe with a soft clean towel to prevent water spotting. If the door panel is stainless steel, it can discolor when exposed to chlorine gas and moisture. Clean stainless steel with a cloth dampened with a mild detergent and warm water solution. Never use an abrasive or caustic cleaning agent.

Interior Cleaning

The kegerator's interior should be cleaned occasionally.

1. Disconnect power to the unit.
2. Open the doors and remove the contents.
3. Wait until the unit defrosts.
4. With a clean cloth, wipe down the interior of the unit.
5. Reconnect power to the unit.

Troubleshooting

Before Calling for Help

If the unit appears to be malfunctioning, read through the "Operation" section of this manual first. If the problem persists, check the Troubleshooting Guide below and on the following page. The problem could be something that can easily be solved or explained.

Symptoms	Possible Causes	Solutions
The kegerator turns on and off frequently.	The room temperature is higher than the recommended ambient temperature.	Run the unit at the appropriate ambient temperature.
	The door is being opened too often.	Minimize the number of times the door is opened.
	The door is not completely closed.	Make sure the door is completely closed.
	The door gasket is not sealing properly.	Make sure the door gasket is properly sealing.
The body of the kegerator is electrified.	The unit is not grounded properly.	Contact your local electrician to test your electrical grounding system.

Troubleshooting Continued

Symptoms	Possible Cause	Solution
The Kegerator does not turn on.	There is a power failure.	Ensure the unit is plugged in and the power outlet has power.
	The unit is not plugged in.	Plug the unit in to a power outlet that has sufficient amperage.
	A house fuse has blown or the circuit breaker is tripped.	Replace the broken fuse in your fuse box or reset the breaker.
The kegerator will not reach the desired temperature.	The unit is placed too close to a heat source.	Keep the unit away from direct sun light or other heat sources.
	The door is opened too frequently or for a long period of time.	Close the door tightly and do not open the door too frequently or for a long period of time.
The kegerator is making strange noises.	Certain sounds are normal.	Read the “Normal Sounds” section.
	The unit is not level or is touching another appliance.	Check to make sure that the kegerator is level, and that it is not in contact with another appliance, or furniture.
Frost is forming in the kegerator.	The space between the top of the kegerator and bottom of the countertop is not sealed properly.	Reference the “Enclose Space Between Cabinet and Countertop” section in this manual.
	The environment is humid.	Though the unit uses an “auto-defrost” system, under certain conditions, manual defrosting may be required. If frost builds up, you can try running the kegerator on a warmer temperature setting, minimizing the number of times you open the door, or unplugging the unit to allow the frost to melt.
	The ambient temperature is too low.	
	The door is being opened too frequently.	
The door will not shut properly.	Your unit is not level.	Make sure the unit is on a level surface.
	The door gasket is dirty.	Clean the door gasket.
	The door gasket is not installed correctly.	Make sure the door gasket is properly installed.

Specifications



Note: Technical data and performance information are provided for reference only.

Description of product	EdgeStar 24" Built-in Kegerator	EdgeStar 24" Built-in Indoor/Outdoor Kegerator	EdgeStar 24" Built-in Kegerator
Model	BR7001SS	BR7001SSOD	BR7001BL
Voltage / Frequency	AC 115 V~60 Hz	AC 115 V~60 Hz	AC 115 V~60 Hz
Amperage	1.5 A	1.5 A	1.5 A
Input Power	120 W	120 W	120 W
Color	Black Cabinet; Stainless Steel Door	Stainless Steel cabinet; Stainless Steel Door	Black Cabinet; Black Powder Coated Stainless Steel Door
Refrigerant	R600a, 1.2 oz.	R600a, 1.2 oz.	R600a, 1.2 oz.
Temperature Range	32°F – 60°F	32°F – 60°F	32°F – 60°F
Dimensions (Height x Width x Depth)	34 ³ / ₈ " X 23 ¹³ / ₁₆ " X 27 ³ / ₈ " **	34 ³ / ₈ " X 23 ¹³ / ₁₆ " X 27 ³ / ₈ " **	34 ³ / ₈ " X 23 ¹³ / ₁₆ " X 27 ³ / ₈ " **
Weight	99 lbs.	90 lbs.	99 lbs.

Specifications are subject to change. Check the rating label on the kegerator for the most accurate information.

** Dimensions are for the fridge only including the handle. Depth without handle is 25 ³/₈". Height with casters and guardrail installed is 40 ³/₄". See dimension guide for additional measurement information.

EdgeStar Limited Warranty

Full One-Year Parts and Labor

This product is warranted by EdgeStar and is subject to any conditions set forth as follows:

WHAT IS COVERED:

For a period of ONE (1) YEAR from the date of original retail purchase, EdgeStar will repair or replace any part free of charge including labor that fails due to a defect in materials or workmanship. Labor will be performed free of charge at an authorized EdgeStar repair facility and EdgeStar will supply new, rebuilt, or refurbished parts free of charge. EdgeStar may request a defective part be returned in exchange for the replacement part. All replacement parts or products will be new, remanufactured, or refurbished. All products and parts replaced by EdgeStar under warranty service become the property of EdgeStar. After the 12 month period, EdgeStar will no longer be responsible for labor charges incurred or replacement parts. All defective products and parts covered by this warranty will be repaired or replaced on a mail-in basis to an EdgeStar authorized repair facility.

This warranty applies to the original purchaser only, and only covers defects in workmanship experienced during operation of the product under normal service, maintenance, and usage conditions. This warranty applies to the purchase and use of this product in residential settings within the contiguous United States of America.

Exceptions: Commercial or Rental Use Warranty

90 days labor and parts from date of original purchase. No other warranty applies.

WHAT IS NOT COVERED- The following limitations apply to the coverage of this warranty. This warranty does not cover:

- Labor charges for installation, setup, or training to use the product.
- Shipping damage, and any damage caused by improper packaging for shipment to an authorized service center, and any damaged caused by improper voltage or any other misuse, including abnormal service, handling, or usage.
- Cosmetic damage such as scratches and dents.
- Normal wear and tear on parts or replacement of parts designed to be replaced, e.g. filters, cartridges, batteries.
- Service trips to deliver, pick-up, or repair, install the product, or to instruct in proper usage of the product.
- Damages or operating problems resulting from misuse, abuse, operation outside environmental specifications, uses contrary to instructions provided in the owner's manual, accidents, acts of God, vermin, fire, flood, improper installation, unauthorized service, maintenance negligence, unauthorized installation or modification, or commercial use.
- Labor, service transportation, and shipping charges for the removal and replacement of defective parts, beyond the initial 12 month period.
- Products that have been modified to perform outside of specifications without the prior written permission of EdgeStar.
- Products lost in shipment, or theft.
- Products sold AS IS or from an unauthorized reseller.
- Products that have had their serial numbers removed, defaced, or with serial numbers that have been invalidated.
- Damage from other than normal household use.
- Replacement or repair of household fuses, circuit breakers, wiring or plumbing.
- Damage to personal property from use of product.
- Damage from service other than from an authorized EdgeStar repair facility.
- Hoses, knobs, lint trays and all attachments, accessories and disposable parts.
- Any service charges not specifically identified as normal such as normal service area or hours.
- Any special or consequential damages arising out of the use of the product.

OBTAINING WARRANTY SERVICE: If you believe your product is defective, contact EdgeStar Customer Support for troubleshooting assistance and warranty service at www.edgestar.com or call 1-866-319-5473. Before contacting Customer Support you are required to have your model number, serial number, and proof of purchase available upon request. Once an EdgeStar authorized representative has confirmed that your product is defective and eligible for warranty service, the product must be returned to an EdgeStar authorized repair facility. EdgeStar is not responsible for damage resulting from shipper mishandling or improper packaging. Do not return a defective product to the place of purchase. Products received without a return authorization number will be refused.

THIS WARRANTY IS IN LIEU OF ANY OTHER WARRANTY, EXPRESS OR IMPLIED, INCLUDING WITHOUT LIMITATION, ANY WARRANTY OF MERCHANTABILITY OR FITNESS FOR A PARTICULAR PURPOSE. TO THE EXTENT ANY IMPLIED WARRANTY IS REQUIRED BY LAW, IT IS LIMITED IN DURATION TO THE EXPRESS WARRANTY PERIOD ABOVE. NEITHER THE MANUFACTURER NOR ITS DISTRIBUTORS SHALL BE LIABLE FOR ANY INCIDENTAL, CONSEQUENTIAL, INDIRECT, SPECIAL, OR PUNITIVE DAMAGES OF ANY NATURE, INCLUDING WITHOUT LIMITATION, LOST REVENUES OR PROFITS, OR ANY OTHER DAMAGE WHETHER BASED IN CONTRACT, TORT, OR OTHERWISE. IN NO EVENT AND UNDER NO CIRCUMSTANCE OF ANY TYPE OR KIND SHALL THE SELLER, MANUFACTURER AND/OR DISTRIBUTOR BE LIABLE FOR ANY REASON, UNDER ANY THEORY, FOR MORE THAN THE BASIC COST OF THE PRODUCT TO THE PURCHASER OR END USER. SOME STATES DO NOT ALLOW THE EXCLUSION OF INCIDENTAL OR CONSEQUENTIAL DAMAGES, SO THE ABOVE EXCLUSION MAY NOT APPLY TO YOU. THIS WARRANTY GIVES YOU SPECIFIC LEGAL RIGHTS. YOU MAY HAVE OTHER RIGHTS THAT VARY FROM STATE TO STATE.