

2190 Boul. Dagenais West  
 LAVAL (QUEBEC)  
 CANADA  
 H7L 5X9

TEL: 514.337.4415  
 FAX: 514.337.4029  
 info@burcam.com

# INSTALLATION INSTRUCTIONS MODELS 503121S

AND  
 OTHER PRODUCTS  
 503127S 503128S  
 503131S  
 ETC.

## JET PUMP

Please read these instructions carefully. **Failure** to comply to instructions and **designed** operation of this system, may **void** the warranty.

Your pump has been carefully packaged at the factory to prevent damage during shipping. However, occasional damage may occur due to rough handling. **Carefully inspect your pump** for damages that could cause failures. Report any damage to your carrier or your point of purchase.

### PRIMING PROCESS

Follow all these inside step by step instructions to install your pump. Use teflon tape on all threads. (1) Fill the suction line with water and connect it to the suction inlet. (2) Remove the priming plug and fill the pump body with water. (3) Screw the plug to the priming inlet. (4) Turn the power on. The pump should deliver water to the plumbing line within 30 seconds. If not, unplug the pump and repeat the process at step 2.

### FACTORY SET VOLTAGE 115 V CONNECTION VOLTAGE CHANGING:

- Before changing the voltage connection:
- A) Ensure the power to the pump is disconnected.
  - B) Open motor junction box cover.
  - C) Please select the up knob position for 115V or down knob position for 230V.
  - D) Connect to appropriate voltage.
  - E) Close motor junction box.

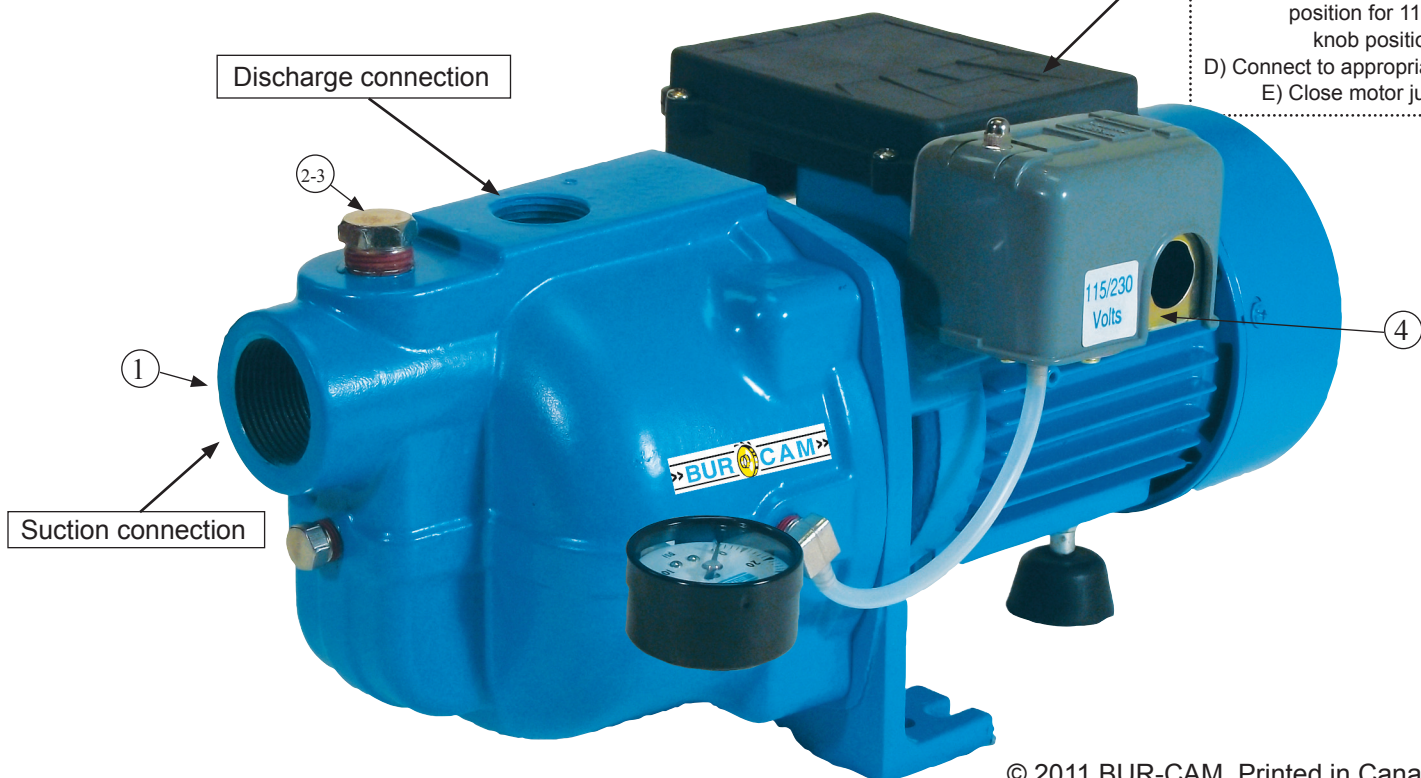

## Safety Instructions:

This fine pump that you have just purchased is designed from the latest in material and workmanship. Before installation and operation, we recommend the following procedures:

- A** CHECK WITH YOUR LOCAL ELECTRICAL AND PLUMBING CODES TO ENSURE YOU COMPLY WITH THE REGULATIONS. THESE CODES HAVE BEEN DESIGNED WITH YOUR SAFETY IN MIND. BE SURE YOU COMPLY WITH THEM.
- B** WE RECOMMEND THAT A SEPARATE CIRCUIT BE LEAD FROM THE HOME ELECTRICAL DISTRIBUTION PANEL PROPERLY PROTECTED WITH A FUSE OR A CIRCUIT BREAKER. WE ALSO RECOMMEND THAT A GROUND FAULT CIRCUIT BE USED. CONSULT A LICENSED ELECTRICIAN FOR ALL WIRING.
- C** THE GROUND TERMINAL ON THE THREE PRONG PLUGS SHOULD NEVER BE REMOVED. THEY ARE SUPPLIED AND DESIGNED FOR YOUR PROTECTION.
- D** NEVER MAKE ADJUSTMENTS TO ANY ELECTRICAL APPLIANCE OR PRODUCT WITH THE POWER CONNECTED. DO NOT ONLY UNSCREW THE FUSE OR TRIP THE BREAKER, REMOVE THE POWER PLUG FROM THE RECEPTACLE.

## Monthly Mandatory check-up:

1. Inspect the pump for any obvious condition that necessitates cleaning, correction, adjustment or repair.
2. Clear the surrounding of any paper, leaves or other debris.
3. Assure that the pump is secure for proper operation.
4. Assure that there is adequate clearance from any combustible materials or structure. Stored materials must be kept away from the pump. Shelves or cabinet structures must not be in close proximity over the pump.
5. Assure that the motor is securely plugged into a proper GFCI electrical outlet.
6. Test the GFCI outlet by pressing its test switch. This should prove that the outlet is energized and will trip off to protect against a ground fault. Be sure to reset the GFCI by pressing its reset switch.
7. Observe that the plumbing can carry the water safely into the residence.

## Material required for drilled well application (indoor use only)

### Shallow well pump installation

- Desired length of polyethylene 1" pipe, 100 PSI, CSA or UL approved, to link up from pumping level to pump.
- 1 1" foot valve (750756 or 750752P).
- 1 well seal, as per well casing diameter (750929 6" x 1").
- 1 1" well seal elbow (750860).
- 2 1" male adaptors (750865 or 750871).
- 8 1" stainless steel clamps (750885).
- Teflon tape.

### Tank installation

- Desired length of 1" braided hose (750919) to link up from pump to tank. Keep tank as close as possible from pump.
- 1 tank T (650651).
- 1 drain valve (650659)
- 2 1" female adaptor.
- 1 1" male adaptor (750865 or 750871).
- 3 1" stainless steel clamps (750885).
- Teflon tape.

### Tools

Screwdrivers, hacksaw to cut pipe, knife to assist in pipe cutting, round file to smooth pipe ends, pipe wrench, adjustable wrench to tighten fittings, propane torch and welding material.

## APPLICATION

- This pump is designed for shallow well installation for water level up to 25 feet.
- CAPACITY AT 20 PSI:

5'	850	US GPH
10'	715	US GPH
15'	630	US GPH
20'	550	US GPH
25'	500	US GPH

FRICITION LOSS IN  
PIPE NOT INCLUDED

## FEATURES

- Easy to prime pump body.
- Totally enclosed, fan cooled motor, bearing to bearing. Built for a continuous use.
- Full time connected run capacitor, to eliminate starting wear vs regular motor.
- Thermal and overload protection.
- Noryl impeller, built-in injector
- 1/2 HP, 115 / 230 VAC, 60 Hz, 8.6 A / 4.3 A (at start: 15 A / 7.5 A).

# INSTALLATION STEPS

## STEP 1

We recommend that you install your pump in a clean and dry location where there is adequate room for servicing at a later date. Protection from freezing temperatures and good ventilation should be considered as well, to provide the pump an environment for long life. Locating the pump as close as possible to the water source will reduce friction losses encountered in the suction pipe.

Friction losses in the suction pipe must be taken into consideration when the horizontal offset is greater than 50 feet. The suction pipes should be increased from 1" to 1 1/4". This will reduce friction losses and allow the pump to give maximum performance.

A new well should be checked to determine that it is free from sand. Sand will damage the seal and the impeller. Have your well driller clean the well before your installation.

**Never run the pump dry.** Damage to the seal may occur. Fill pump body and suction pipe with water before turning on the power.

THE RUN OF HORIZONTAL PIPE FROM THE TOP OF YOUR WELL INTO THE HOUSE, WHERE YOUR PUMP WILL BE LOCATED, MUST BE INSTALLED IN A TRENCH, BELOW THE FROST LEVEL OF YOUR AREA.

# SHALLOW WELL APPLICATION

SEE DIAGRAM ON PAGE 7

## STEP 2

Cut the desired length of poly pipe to run from the top of the well to the pumping level. Smooth the pipe cuttings with your round file. (Check that no cut-out parts are left inside of pipe. This may block pump injector or impeller). Tape male adaptor threads with teflon tape and thread adaptor into the foot valve. Slide 2 stainless steel clamps over one end of pipe and use torch to soften pipe. Insert the male adaptor and foot valve into this pipe end. Tighten clamps with screwdriver when cool. **For security against leaks, we suggest to install 2 stainless steel clamps on each adaptor.**

## STEP 3

Insert the well seal elbow thru the opening of the seal. Slide 2 stainless steel clamps over the free end of the previously cut pipe and soften pipe with your torch. Attach pipe to the well seal elbow (end protruding at bottom of well seal). Tighten clamps with screwdriver when cool.

## STEP 4

Install the well seal and piping assembly into your well casing. Tight down the well seal bolts using your adjustable wrench.

To facilitate servicing at a later date, you may use a pitless adaptor and a sealed well cap instead of an elbow and a well seal as describe in steps 3 and 4.

## STEP 5

Install your pump in the house, on a sound foundation, as close as possible to the basement wall. Locate the suction inlet in the front of the injector. Thread an adaptor into inlet using teflon tape. Do not over tighten.

## STEP 6

Cut the desired length of pipe from pump location to the well seal and connect both ends using the previous way, with stainless steel clamps and torch. **Do not fill in your trench to the house until you have checked for any leaks in your connections or trouble in your water system.**

## STEP 7

for sand  
or well  
points

Sand or well points are limited to areas where water bearing sand or gravel lies below the surface, and where there are no boulders or rocks to interfere with the driving into the ground of the point.

The amount of water any "one" well point will supply is usually rather limited. Sometimes, it is necessary to use more than one point to increase the supply of water, entering to the pump's suction.

THE IMPORTANT INSTALLATION STEP IN USING WELL POINTS IS THAT A CHECK VALVE MUST BE USED IN THE SUCTION PIPE LEADING TO THE SUCTION INLET, AS CLOSE TO THE PUMP AS POSSIBLE, TO KEEP SUCTION LINE AND PUMP WELL PRIMED.

CONTINUE ON PAGE 5 & 6 FOR TANKS AND ELECTRICAL INSTALLATION STEPS

# TANKS INSTALLATION

SEE DIAGRAM ON PAGE 8

## STEP 8 for captive air tanks

Packaged systems have the pump mounted directly to the tank. The pump to tank plumbing fittings are pre-assembled in factory. You only have to connect the discharge line of your system to your home's plumbing distribution line. When using a separate tank from your pump, we recommend to install a captive air tank as shown in our typical installation diagram, that is air injected into the tank at the factory. This air, which is in addition to atmospheric pressure, increase the ability of the tank to deliver more water between on/off cycles, thus increasing the efficiency of your water system. Connect the pump discharge to the tank T, using adaptors and braided hose, then, connect the other side of tank T to your home's plumbing distribution line.

**Make sure that the precharged air pressure (before connecting the tank) is 2 PSI less than the starting pressure setted on the pressure switch of your pump.** If you adjust the air pressure after the installation, follow these steps:

- Check the starting pressure of the pump on the pressure gauge;
- Disconnect the power to the pump;
- Open nearest fawcet to the tank and relieve all pressure in tank, then close the fawcet;
- Adjust the air pressure of the tank (by pumping or removing air at the snifter valve) 2 PSI below pressure switch "ON" setting;
- Turn power back on to pump.

Your tank is now well precharged. Run the pump through a few cycles to verify that it works properly.

## STEP 8 for epoxy or glass lined tanks

Other types of tanks may be used, as galvanized standard tanks, epoxy or glass lined tanks. These products do not achieve the benefits of the captive air tanks.

Epoxy or glass lined tanks with float have to be precharged by the installer. Assuming tank is plumbed to pump and all connections are checked for leaks, follow these steps:

- Run pump thru one complete cycle, until pump shuts off;
- Disconnect the power to the pump;
- Open nearest fawcet to the tank and relieve all pressure in tank, then close the fawcet;
- Close service line gate valve;
- With a car tire pump, inject air into the snifter valve located in tank. Watch pump pressure gauge and stop pumping air when pressure reaches 2 PSI below pressure switch "ON" setting;
- Return power back on to pump;
- Run pump through one complete cycle;
- Open service line gate valve.

Your tank is now well precharged. Run the pump through a few cycles to verify that it works properly.

Not  
recommended  
for galvanized  
tanks

Galvanized standard tanks require an air volume control to be used with jet pump. We do not recommend the installation of this type of tank with your jet pump. This type of galvanized tank is recommended with piston pumps.



# ELECTRICAL INSTALLATION

## STEP 9

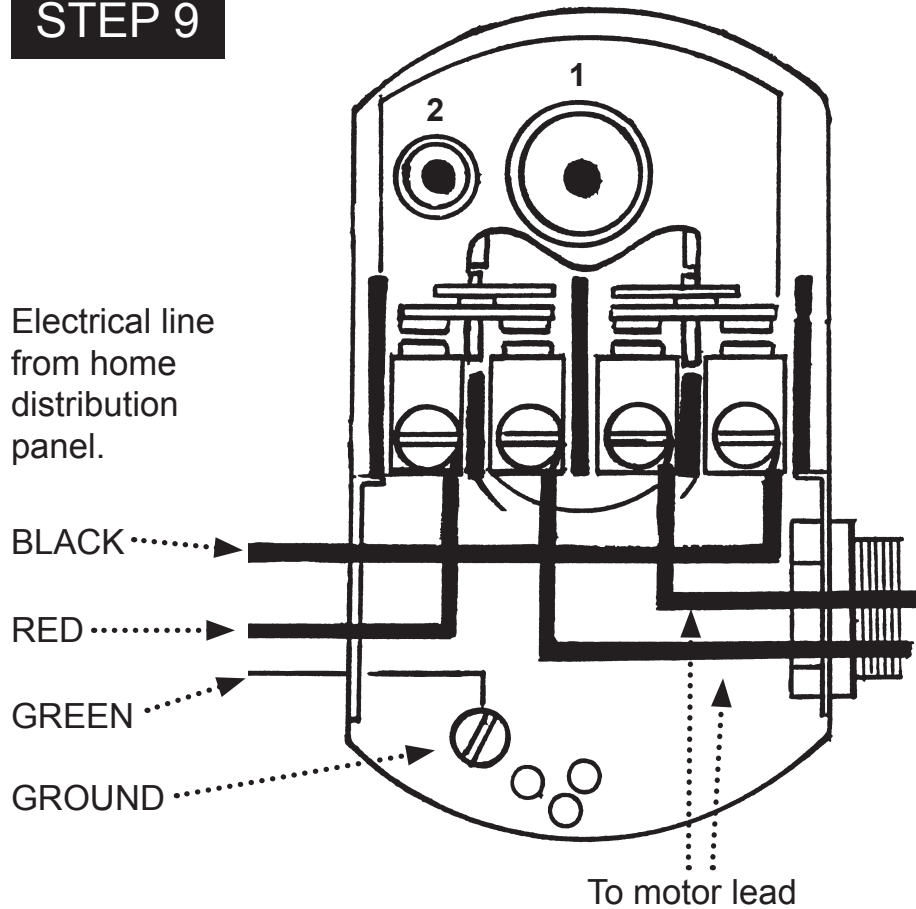

### VOLTAGE SELECTION SWITCH

1. POWER off.
2. Please SELECT the up knob position for 115 V or down knob position for 230 V.

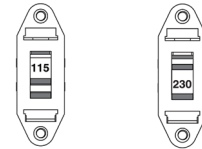

3. CONNECT to appropriate power source.

We recommend that a licensed electrician be employed to do the proper wiring to the pressure switch, and to permanently ground the motor in accordance to the electrical codes in your area.

Do not use an extension cord to connect your pump to the power source. From your distribution panel to the pressure switch, we recommend a wire gauge not smaller than 14 gauge.

This is a dual voltage 115/230 pump. The voltage selection switch is located inside the terminal box. The motor is factory wired on 115V. For 230V selection, please open the terminal cover and set the switch to the proper voltage. (See above drawing on right ).

Pressure switch setting (start/stop 20/40 or 30/50) has been made at the factory. Adjustments may be done to give other operating pressures.

Adjustment or modification of start/stop setting of pressure switch have to be done carefully.  
**Turn adjustment nut half turn at a time.**

Turn nut 1 clockwise to raise start and stop pressure setting. **Never turn nut 2. This will change the 20 PSI range between start and stop pressure and may damage your tank's bladder or modify the efficiency of your water system.** Check system operation after each adjustment.

# SHALLOW WELL APPLICATION

**STEP 5** Install your pump and thread an adaptor into inlet.

**STEP 6** Cut poly pipe and connect both ends.

**STEP 3** Insert well seal elbow through the seal and attach to pipe.

**STEP 4** Install well seal and piping into well casing.

**STEP 2** Cut poly pipe and install the check valve.

## Well point optional installation

**STEP 7** You may install one or more sand points to increase the supply of water.

Check valve,  
close to pump.

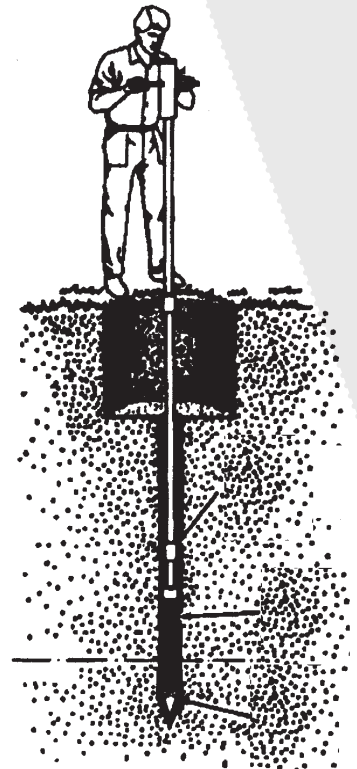
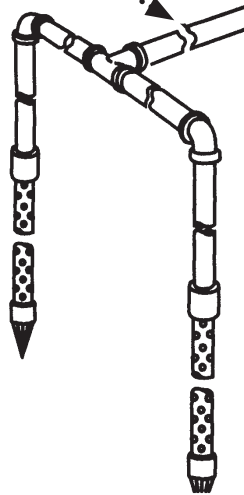

# TANK INSTALLATION

Snifter valve to adjust air pressure

Pressure switch  
1/4" connection  
if not include  
with the pump.

Relief valve for  
pumps with more  
than 75 PSI of  
capacity 1/2"  
connection

Pressure gauge  
1/4" connection

Drain valve  
1/2" connection

1" MNPT or 3/4"  
FNPT connection

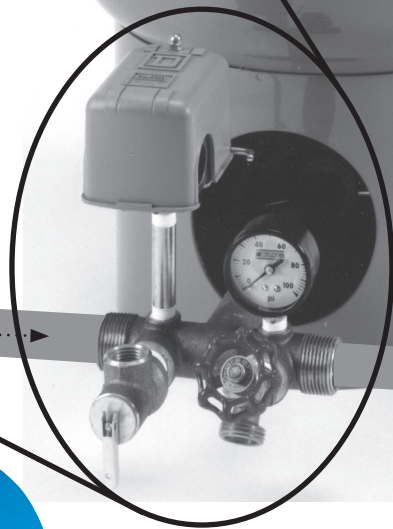

**STEP 8** Connect the pump discharge to the tank 'T'

From well

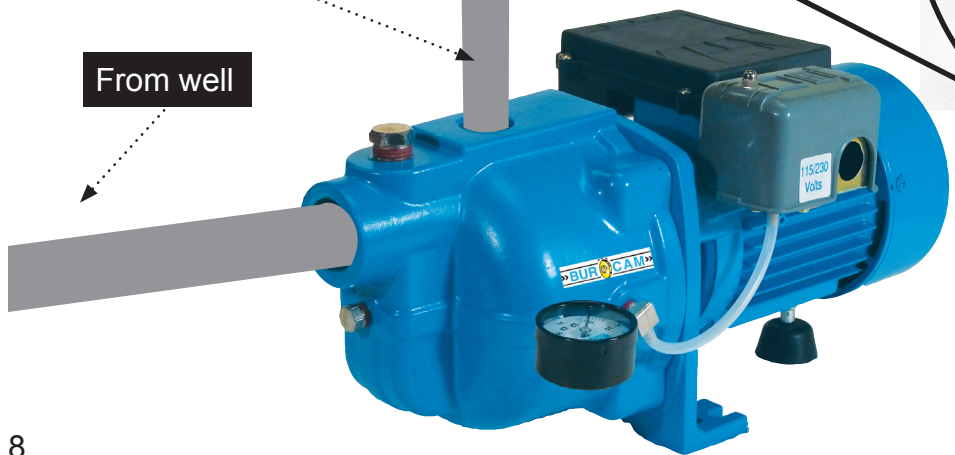

To home's plumbing  
distribution line



# REPAIR PARTS

Ref	Pieces	Descriptions	Ref	Pieces	Descriptions
1	510054	Motor	10	510065	Diffuser Plate
2	510055	Motor Screws (4)	11	510051	Diffuser Plate O-Ring
3	750957S	Pressure Switch	12	510050	Diffuser Plate Washers (3)
4	510056	1/4" NPT 1/4" Barb Elbow	13	510049	Diffuser Plate Screws (3)
5	750748	Hose	14	510069	Venturi
6	510053	Seal Plate O-Ring	15	510046	Nozzle
7	510052	Macanical Seal	16	510056	1/4" NPT 1/4" Barb Elbow
8	510048	Impeller	17	510045	Pump Body
9	510047	Diffuser	18	750769	1/4" Pressure Gauge (not shown)

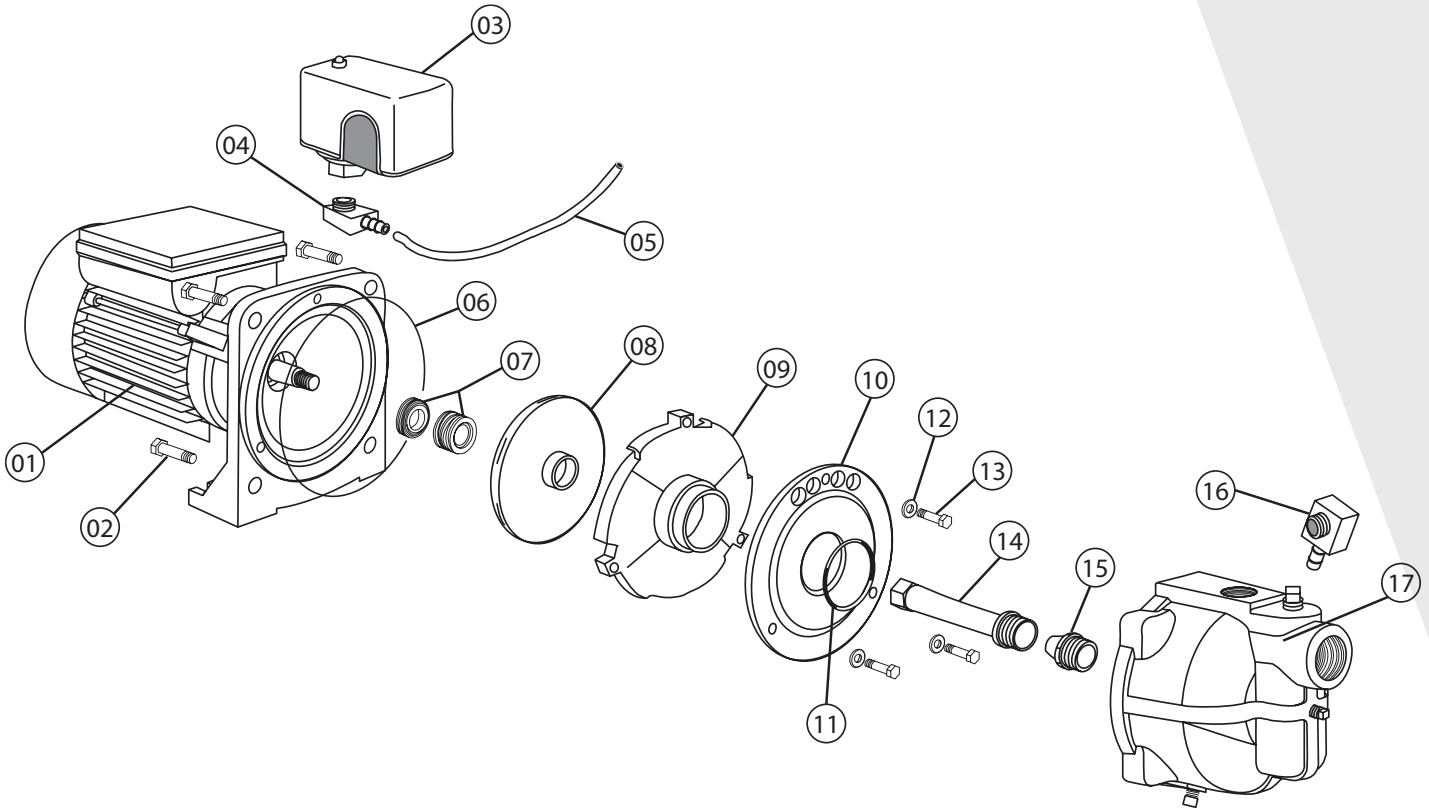

503121S 2011

Repair parts may be ordered from your authorized point of sale or from  
**BUR-CAM PUMPS**

**FOR INFORMATION TEL: 514.337.4415 FAX: 514.337.4029**

# TROUBLE SHOOTING GUIDE CHECKLIST

NEVER MAKE ADJUSTMENTS TO ANY ELECTRICAL APPLIANCE OR PRODUCT WITH THE POWER CONNECTED. DON'T JUST UNSCREW THE FUSE OR TRIP THE BREAKER, REMOVE THE POWER FROM THE RECEPTACLE.

TROUBLE	PROBABLE CAUSE	ACTION
Motor does not run.	Switch is off position Blown fuse Tripped breaker Dirty pressure switch Defective pressure switch Defective motor	Turn switch to on position Replace Reset Clean Replace Replace
Motor runs but no water is delivered.	Pump not primed Leaky suction line Foot valve plugged Ejector nozzle clogged Water level below foot valve Suction lift to great Improper voltage	Prime with clean water Check pipe and pipe connections Clean Clean Check foot valve level Water level lower than lift capacity Check voltage
Pump does not deliver to full capacity.	Water level below foot valve Ejector nozzle clogged Excessive friction in pipe Improper voltage	Check foot valve level Clean Too small or dirty pipe Check voltage
Pump does not shut off.	Leaky discharge line Motor not up to normal speed Improper setting of pressure switch Ejector nozzle clogged	Check all pipes for leak Check power cable and voltage Reset or replace Clean
Pump starts and stop too often.	Pressure tank waterlogged Leaky foot valve Leaky suction line Foot valve do not close properly Pressure switch out of adjustment Leaky discharge line (toilet etc.)	Drain tank and restart Replace Check pipe and pipe connections Clean or replace Adjust on/off setting Check all pipes for leak
Air spurts from faucets.	Leaky suction line Gaz in water Airlogged tank (galvanized)	Check pipe and pipe connections Check and consult factory Replace air volume control

## TO THE END CONSUMER

*If you have any problems with the product, before advising the store, where you've purchased the pump, please contact us at 514 337-4415 , and ask for our sales department, and they will be pleased to help you with any questions you might have, concerning your installation.*