

INSTALLATION INSTRUCTIONS

2190 Dagenais Blvd. West
LAVAL (QUEBEC)
CANADA
H7L 5X9

TEL: 514.337.4415
FAX: 514.337.4029
info@burcam.com

**MODEL
506518SS**

AND BY-PRODUCTS LIKE

**506537SS 506547SS
506538SS 506548SS,
506541SS ETC.**

JET PUMP

Please read these instructions carefully.

Failure to comply to instructions and **designed** operation of this system, may **void** the warranty.

Your pump has been carefully packaged at the factory to prevent damage during shipping. However, occasional damage may occur due to rough handling. **Carefully inspect your pump for damages that could cause failures. Report any damage to your carrier or your point of purchase.**

**Factory set voltage 115 V
Connecting volatge changing :**

- Before changing the voltage connection :
- A) Ensure the power to the pump is disconnected.
 - B) Open motor junction box cover.
 - C) Please select the up knob position for 115 V or down knob position for 230 V.
 - D) Connect to appropriate power source.
 - E) Close motor junction box.



SAFETY INSTRUCTIONS:

This fine pump that you have just purchased is designed from the latest in material and workmanship. Before installation and operation, we recommend the following procedures:

- A** CHECK WITH YOUR LOCAL ELECTRICAL AND PLUMBING CODES TO ENSURE YOU COMPLY WITH THE REGULATIONS. THESE CODES HAVE BEEN DESIGNED WITH YOUR SAFETY IN MIND. BE SURE YOU COMPLY WITH THEM.
- B** WE RECOMMEND THAT A SEPARATE CIRCUIT BE LEAD FROM THE HOME ELECTRICAL DISTRIBUTION PANEL PROPERLY PROTECTED WITH A FUSE OR A CIRCUIT BREAKER. THE MOTOR HAVE TO BE SECURELY PLUGGED INTO A PROPER 'GFCI' ELECTRICAL OUTLET. CONSULT A LICENSED ELECTRICIAN FOR ALL WIRING.
- C** THE GROUND TERMINAL ON THE THREE PRONG PLUGS SHOULD NEVER BE REMOVED. THEY ARE SUPPLIED AND DESIGNED FOR YOUR PROTECTION.
- D** NEVER MAKE ADJUSTMENTS TO ANY ELECTRICAL APPLIANCE OR PRODUCT WITH THE POWER CONNECTED. DO NOT ONLY UNSCREW THE FUSE OR TRIP THE BREAKER, REMOVE THE POWER PLUG FROM THE RECEPTACLE.

MONTHLY MANDATORY CHECK-UP :

1. Inspect the pump for any obvious condition that necessitates cleaning, correction, adjustment or repair.
2. Assure that the pump is secure for proper operation.
3. Assure that there is adequate clearance from any combustible materials or structure. Stored materials must be kept away from the pump. Shelves or cabinet structures must not be in close proximity over the pump.
4. Test the 'GFCI' outlet by pressing its test switch. This should prove that the outlet is energized and will trip off to protect against a ground fault. Be sure to reset the 'GFCI' by pressing its reset switch.
5. Observe that the plumbing can distribute the pumped water safely in the residence.

MATERIAL REQUIRED FOR DRILLED WELL APPLICATION (indoor use only)

Shallow well pump installation

- o Desired length of polyethylene 1" pipe, 100 PSI, CSA or UL approved, to link up from pumping level to pump.
- o 1 1" foot valve (750756 or 750752P).
- o 1 well seal, as per well casing diameter (750929 6" x 1").
- o 1 1" well seal elbow (750860).
- o 2 1" male adaptors (750865 or 750871).
- o 8 1" stainless steel clamps (750885).
- o Teflon tape.

Tools

Screwdrivers, hacksaw to cut pipe, knife to assist in pipe cutting, round file to smooth pipe ends, pipe wrench, adjustable wrench to tighten fittings.

Tank installation

- o Desired length of 1" braided hose (750919) to link up from pump to tank. Keep tank as close as possible from pump.
- o 1 tank T (650651).
- o 1 drain valve (650659)
- o 2 1" female adaptor.
- o 1 1" male adaptor (750865 or 750871).
- o 3 1" stainless steel clamps (750885).
- o Teflon tape.

NOTICE

This unit is not designed for applications involving salt water or brine. Use with salt water or brine will void warranty.

APPLICATION

o This pump is designed for shallow well installation for a suction level up to 25 feet.

o Capacity at 20 PSI:

5'	900 US GPH
10'	750 US GPH
15'	640 US GPH
20'	560 US GPH
25'	475 US GPH

FRICITION LOSS IN PIPE
NOT INCLUDED

FEATURES

- o 304 stainless steel pump body, easy to prime.
- o Totally enclosed, fan cooled motor, bearing to bearing. Built for a continuous use.
- o Full time connected run capacitor, to eliminate starting wear vs regular motor.
- o Thermal and overload protection.
- o Noryl impeller, built-in injector
- o 3/4HP, 115/230V AC, 60Hz, 9A, 18A (when start).

INSTALLATION STEPS

NEVER RUN THE PUMP DRY

STEP 1

We recommend that you install your pump in a clean and dry location where there is adequate room for servicing at a later date. Protection from freezing temperatures and good ventilation should be considered as well, to provide the pump an environment for long life. Locating the pump as close as possible to the water source will reduce friction losses encountered in the suction pipe.

Friction losses in the suction pipe must be taken into consideration when the horizontal offset is greater than 50 feet. The suction pipes should be increased from 1" to 1 1/4". This will reduce friction losses and allow the pump to give maximum performance.

A new well should be checked to determine that it is free from sand. Sand will damage the seal and the impeller. Have your well driller clean the well before your installation.

Never run the pump dry. Damage to the seal may occur. Fill pump body and suction pipe with water before turning on the power.

THE RUN OF HORIZONTAL PIPE FROM THE TOP OF YOUR WELL INTO THE HOUSE, WHERE YOUR PUMP WILL BE LOCATED, MUST BE INSTALLED IN A TRENCH, BELOW THE FROST LEVEL OF YOUR AREA.

SHALLOW WELL APPLICATION

(SEE DIAGRAM ON PAGE 7)

STEP 2

Cut the desired length of poly pipe to run from the top of the well to the pumping level. Smooth the pipe cuttings with your round file. (Check that no cut-out parts are left inside of pipe. This may block pump injector or impeller).

Tape male adaptor threads with teflon tape and thread adaptor into the foot valve. Slide 2 stainless steel clamps over one end of pipe and use torch to soften pipe. Insert the male adaptor and foot valve into this pipe end. Tighten clamps with screwdriver when cool. **For security against leaks, we suggest to install 2 stainless steel clamps on each adaptor.**

STEP 3

Insert the well seal elbow thru the opening of the seal.

Slide 2 stainless steel clamps over the free end of the previously cut pipe and soften pipe with your torch. Attach pipe to the well seal elbow (end protruding at bottom of well seal). Tighten clamps with screwdriver when cool.

STEP 4

Install the well seal and piping assembly into your well casing. Tight down the well seal bolts using your adjustable wrench.

To facilitate servicing at a later date, you may use a pitless adaptor and a sealed well cap instead of an elbow and a well seal as describe in steps 3 and 4.

STEP 5

Install your pump in the house, on a sound foundation, as close as possible to the basement wall. Locate and screw your injector body to your pump body. Locate the suction inlet in the front of the injector. Thread an adaptor into inlet using teflon tape. Do not over tighten.

STEP 6

Cut the desired length of pipe from pump location to the well seal and connect both ends using the previous way, with stainless steel clamps and torch.

Do not fill in your trench to the house until you have checked for any leaks in your connections or trouble in your water system.

STEP 7 for sand or well points

Sand or well points are limited to areas where water bearing sand or gravel lies below the surface, and where there are no boulders or rocks to interfere with the driving into the ground of the point.

The amount of water any "one" well point will supply is usually rather limited. Sometimes, it is necessary to use more than one point to increase the supply of water, entering to the pump's suction.

THE IMPORTANT INSTALLATION STEP IN USING WELL POINTS IS THAT A CHECK VALVE MUST BE USED IN THE SUCTION PIPE LEADING TO THE SUCTION INLET, AS CLOSE TO THE PUMP AS POSSIBLE, TO KEEP SUCTION LINE AND PUMP WELL PRIMED.

CONTINUE ON PAGE 5 & 6 FOR TANKS AND ELECTRICAL INSTALLATION STEPS

FOR INFORMATION

TEL: 514.337.4415

FAX: 514.337.4029

TANKS INSTALLATION

(SEE DIAGRAM ON PAGE 8)

STEP 9

Packaged systems have the pump mounted directly to the tank. The pump to tank plumbing fittings are pre-assembled in factory. You only have to connect the discharge line of your system to your home's plumbing distribution line.

When using a separate tank from your pump, we recommend to install a captive air tank as shown in our typical installation diagram, that is air injected into the tank at the factory. This air, which is in addition to atmospheric pressure, increase the ability of the tank to deliver more water between on/off cycles, thus increasing the efficiency of your water system. Connect the pump discharge to the tank T, using adaptors and braided hose, then, connect the other side of tank T to your home's plumbing distribution line.

Make sure that the precharged air pressure (before connecting the tank) is 2 PSI less than the starting pressure setted on the pressure switch of your pump.

If you adjust the air pressure after the installation, follow these steps:

- Check the starting pressure of the pump on the pressure gauge;
- Disconnect the power to the pump;
- Open nearest faucet to the tank and relieve all pressure in tank, then close the faucet;
- Adjust the air pressure of the tank (by pumping or removing air at the snifter valve) 2 PSI below pressure switch "ON" setting;
- Turn power back on to pump.

Your tank is now well precharged. Run the pump through a few cycles to verify that it works properly.

STEP 9 for epoxy or glass lined tanks

Other types of tanks may be used, as galvanized standard tanks, epoxy or glass lined tanks. These products do not achieve the benefits of the captive air tanks.

Epoxy or glass lined tanks with float have to be precharged by the installer. Assuming tank is plumbed to pump and all connections are checked for leaks, follow these steps:

- Run pump thru one complete cycle, until pump shuts off;
- Disconnect the power to the pump;
- Open nearest faucet to the tank and relieve all pressure in tank, then close the faucet;
- Close service line gate valve;
- With a car tire pump, inject air into the snifter valve located in tank. Watch pump pressure gauge and stop pumping air when pressure reaches 2 PSI below pressure switch "ON" setting;
- Return power back on to pump;
- Run pump through one complete cycle;
- Open service line gate valve.

Your tank is now well precharged. Run the pump through a few cycles to verify that it works properly.

Not recommended for galvanized tanks

Galvanized standard tanks require an air volume control to be used with jet pump. We do not recommend the installation of this type of tank with your jet pump. This type of galvanized tank is recommended with piston pumps.

ELECTRICAL INSTALLATION

STEP 10

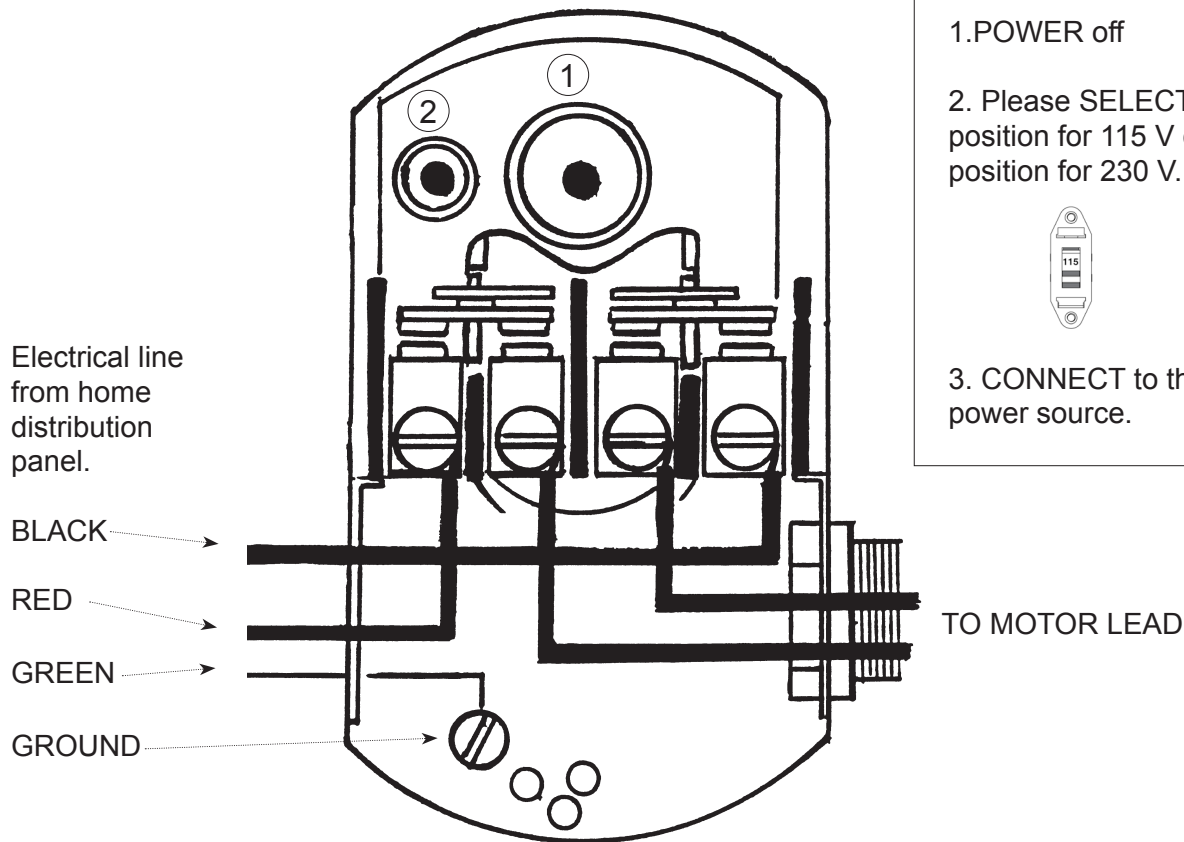

VOLTAGE SELECTION SWITCH

1. POWER off

2. Please SELECT the up knob position for 115 V or down knob position for 230 V.

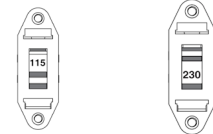

3. CONNECT to the appropriate power source.

We recommend that a licensed electrician be employed to do wiring to the pressure switch. Permanently ground the motor in accordance to the electrical codes for your area.

Do not use an extension cord to connect your pump to the power source. From your distribution panel to the pressure switch, we recommend a wire gauge not smaller than 14 gauge.

Pressure switch setting (start/stop 20/40 or 30/50) has been made in factory. An adjustment may be done to give other operating pressures.

Adjustment or modification of start/stop setting of pressure switch have to be done carefully. **Turn adjustment nut half turn at a time.**

Turn nut 1 clockwise to raise start and stop pressure setting. **Never turn nut 2. This will change the 20 PSI range between start and stop pressure and may damage your tank's bladder or modify the efficiency of your water system.** Check system operation after each adjustment.

SHALLOW WELL APPLICATION

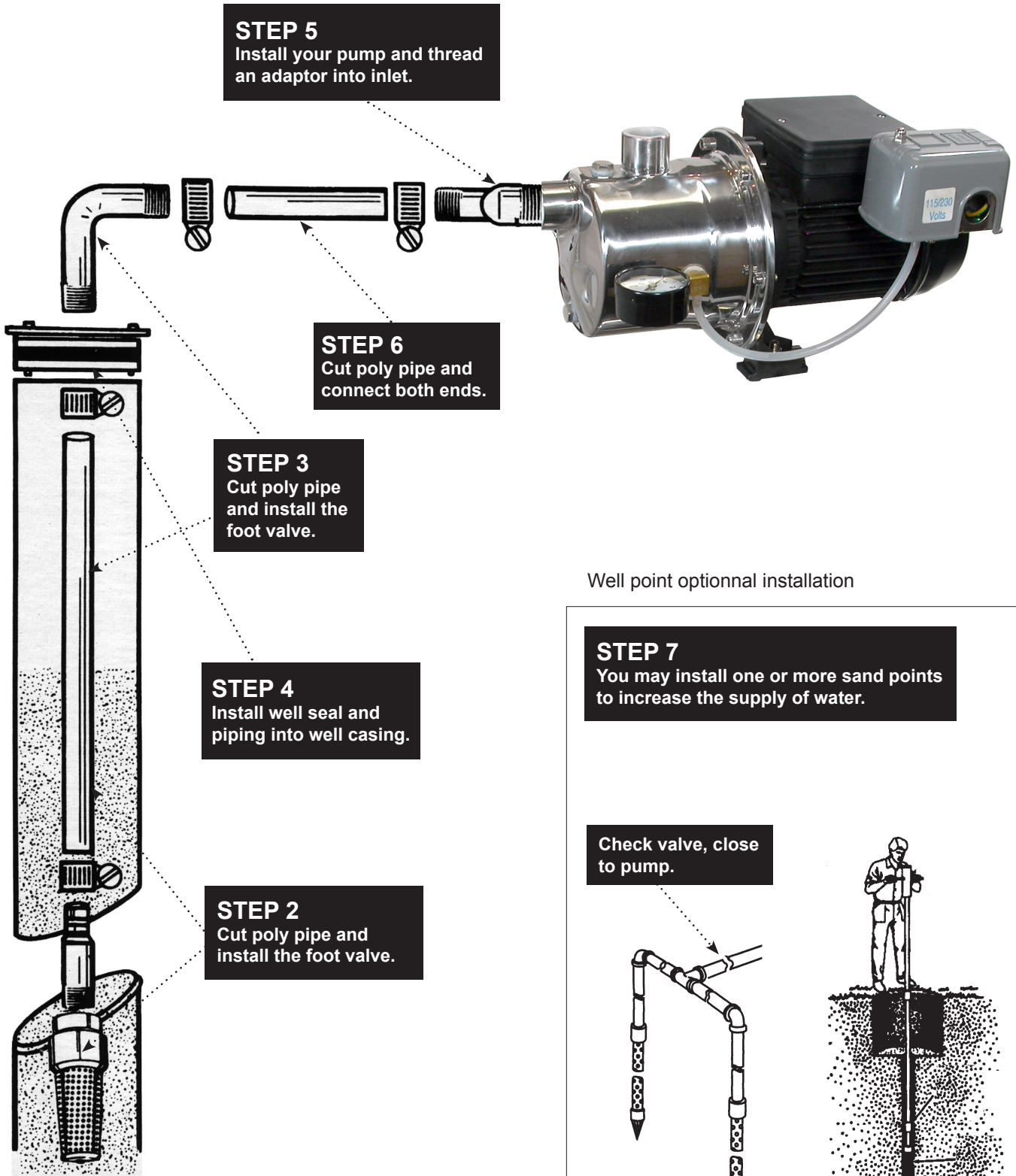

STEP 5
Install your pump and thread an adaptor into inlet.

STEP 6
Cut poly pipe and connect both ends.

STEP 3
Cut poly pipe and install the foot valve.

STEP 4
Install well seal and piping into well casing.

STEP 2
Cut poly pipe and install the foot valve.

Well point optional installation

STEP 7
You may install one or more sand points to increase the supply of water.

Check valve, close to pump.

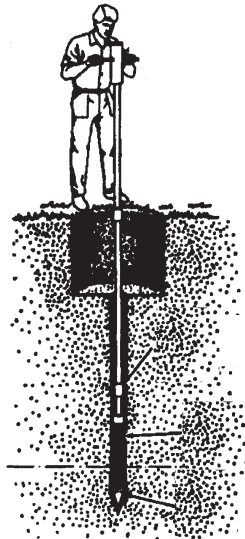
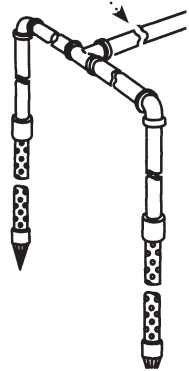

TANK INSTALLATION

Pressure switch
1/4" connection

Snifer valve to
adjust air pressure

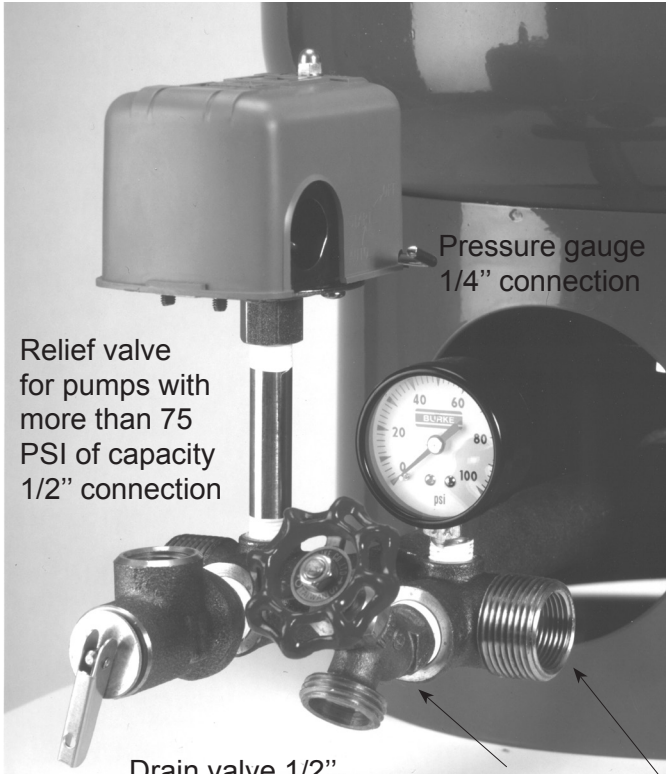

Pressure gauge
1/4" connection

Relief valve
for pumps with
more than 75
PSI of capacity
1/2" connection

Drain valve 1/2"
connection

1" MNPT or 3/4" FNPT
connection



STEP 9
Connect the pump
discharge to the tank 'T'

To home's plumbing
distribution line

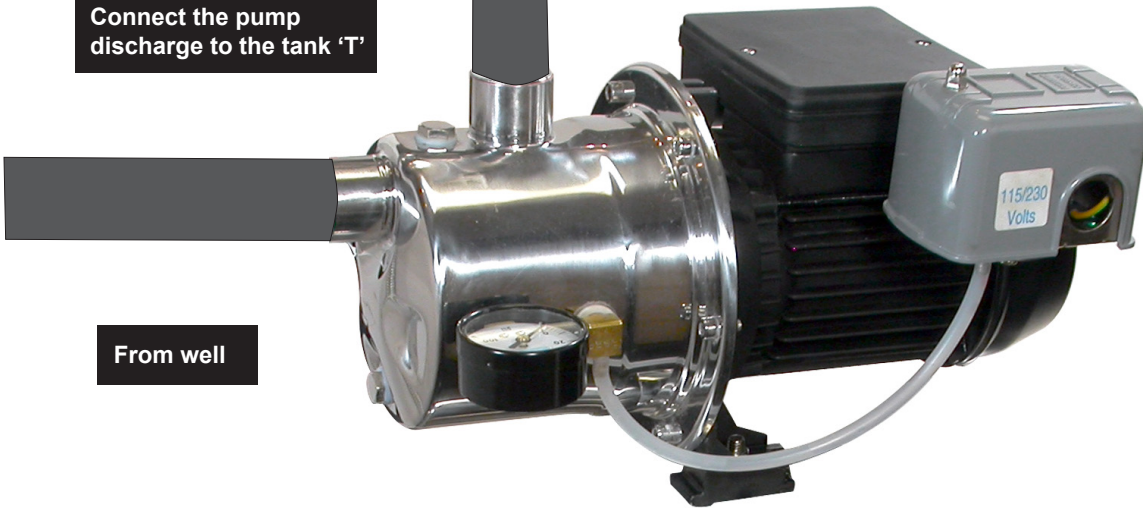

From well

FOR INFORMATION

TEL: 514.337.4415

FAX: 514.337.4029

REPAIR PARTS Model 506518SS (version "w")

REF ITEM	DESCRIPTION	REF ITEM	DESCRIPTION
1	510000 Pump body	11	510010 Seal plate
2	510001 Priming / drainage plugs (2)	12	510011 Water slinger
3	750769 Pressure gauge	13	510012 Motor
4	510003 Pump body screw (6)	14	510013 Capacitor
5	510004 Venturi O - Ring	15	510014 Junction box cover
6	510005 Venturi / Diffuser	16	510015 Motor foot
7	510006 Impeller	31	510016 Tube fitting
8	510007 Washer	32	510017 Tube
9	510008 Mechanical seal	33	510018 Pressure switch
10	510009 Seal plate O-Ring		

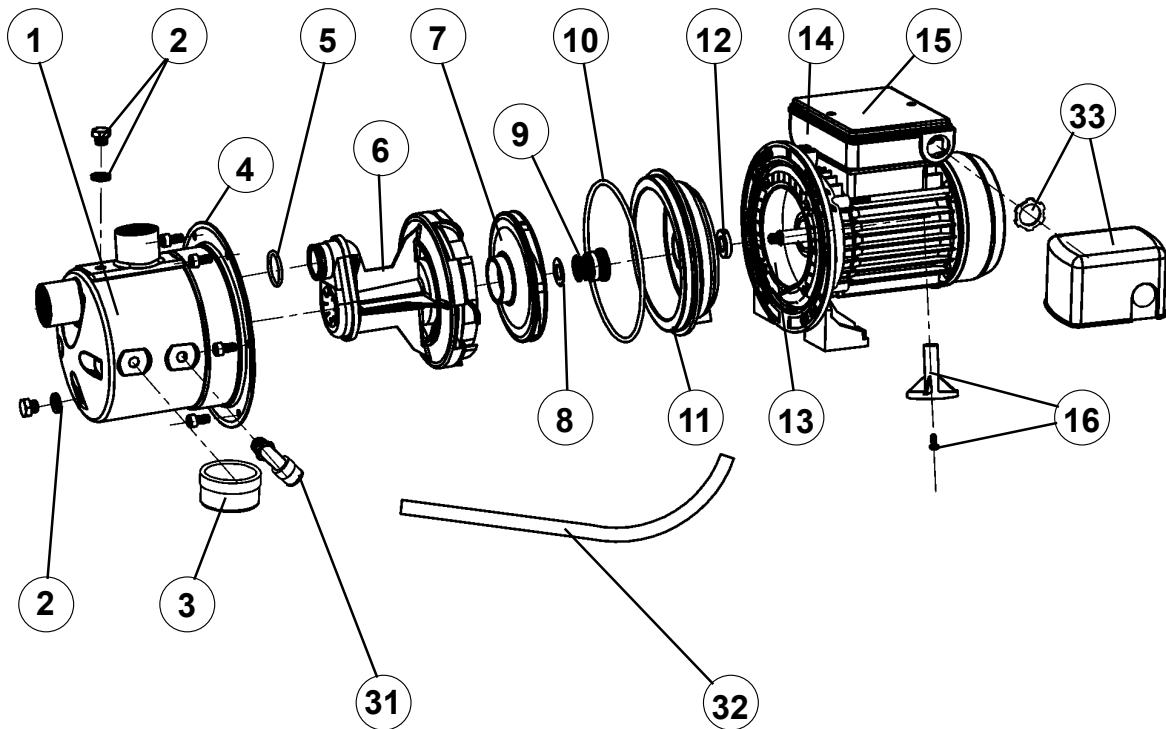

506518SSW 2009

Repair parts may be ordered from your authorized point of sale or from BURCAM PUMPS

FOR INFORMATION

TEL: 514.337.4415

FAX: 514.337.4029

TROUBLE SHOOTING GUIDE CHECKLIST

NEVER MAKE ADJUSTMENTS TO ANY ELECTRICAL APPLIANCE OR PRODUCT WITH THE POWER CONNECTED. DON'T JUST UNSCREW THE FUSE OR TRIP THE BREAKER, REMOVE THE POWER FROM THE RECEPTACLE.

TROUBLE	PROBABLE CAUSE	ACTION
Motor does not run.	<ul style="list-style-type: none"> Switch is off position Blown fuse Tripped breaker Dirty pressure switch Defective pressure switch Defective motor 	<ul style="list-style-type: none"> Turn switch to on position Replace Reset Clean Replace Replace
Motor runs but no water is delivered.	<ul style="list-style-type: none"> Pump not primed Leaky suction line Foot valve plugged Ejector nozzle clogged Water level below foot valve Suction lift to great Improper voltage 	<ul style="list-style-type: none"> Prime with clean water Check pipe and pipe connections Clean Clean Check foot valve level Water level lower than lift capacity Check voltage
Pump does not deliver to full capacity.	<ul style="list-style-type: none"> Water level below foot valve Ejector nozzle clogged Excessive friction in pipe Improper voltage 	<ul style="list-style-type: none"> Check foot valve level Clean Too small or dirty pipe Check voltage
Pump does not shut off.	<ul style="list-style-type: none"> Leaky discharge line Motor not up to normal speed Improper setting of pressure switch Ejector nozzle clogged 	<ul style="list-style-type: none"> Check all pipes for leak Check power cable and voltage Reset or replace Clean
Pump starts and stop too often.	<ul style="list-style-type: none"> Pressure tank waterlogged Leaky foot valve Leaky suction line Foot valve do not close properly Pressure switch out of adjustment Leaky discharge line (toilet etc.) 	<ul style="list-style-type: none"> Drain tank and restart Replace Check pipe and pipe connections Clean or replace Adjust on/off setting Check all pipes for leak
Air spurts from faucets.	<ul style="list-style-type: none"> Leaky suction line Gaz in water Airlogged tank (galvanized) 	<ul style="list-style-type: none"> Check pipe and pipe connections Check and consult factory Replace air volume control

TO THE END CONSUMER

If you have any problems with the product, before advising the store, where you've purchased the pump, please contact us at 514 337-4415 , and ask for our sales department, and they will be pleased to help you with any questions you might have, concerning your installation.

FOR INFORMATION

TEL: 514.337.4415

FAX: 514.337.4029