

2190 Boul. Dagenais West
LAVAL (QUEBEC)
CANADA
H7L 5X9

TEL: 514.337.4415
FAX: 514.337.4029
info@burcam.com

INSTALLATION INSTRUCTIONS MODEL 506532SS

DUAL APPLICATION PUMP

Your pump has been carefully packaged at the factory to prevent damage during shipping. However, occasional damage may occur due to rough handling. **Carefully inspect your pump** for damages that could cause failures. Report any damage to your carrier or your point of purchase.

Please read these instructions carefully. **Failure** to comply to instructions and **designed** operation of this system, may **void** the warranty.



Shallow Well
Pump application

Page 4

Booster pump application

Page 7

SAFETY INSTRUCTIONS:

This fine pump that you have just purchased is designed from the latest in material and workmanship.

Before installation and operation, we recommend the following procedures:

A CHECK WITH YOUR LOCAL ELECTRICAL AND PLUMBING CODES TO ENSURE YOU COMPLY WITH THE REGULATIONS. THESE CODES HAVE BEEN DESIGNED WITH YOUR SAFETY IN MIND. BE SURE YOU COMPLY WITH THEM.

B WE RECOMMEND THAT A SEPARATE CIRCUIT BE LEAD FROM THE HOME ELECTRICAL DISTRIBUTION PANEL PROPERLY PROTECTED WITH A FUSE OR A CIRCUIT BREAKER. WE ALSO RECOMMEND THAT A GROUND FAULT CIRCUIT BE USED. CONSULT A LICENSED ELECTRICIAN FOR ALL WIRING.

C THE GROUND TERMINAL ON THE THREE PRONG PLUGS SHOULD NEVER BE REMOVED. THEY ARE SUPPLIED AND DESIGNED FOR YOUR PROTECTION.

D NEVER MAKE ADJUSTMENTS TO ANY ELECTRICAL APPLIANCE OR PRODUCT WITH THE POWER CONNECTED. DO NOT ONLY UNSCREW THE FUSE OR TRIP THE BREAKER, REMOVE THE POWER PLUG FROM THE RECEPTACLE.

Material required for drilled well application (indoor use only)

Shallow well pump installation

- Desired length of polyethylene 1" pipe, 100 PSI, CSA or UL approved, to link up from pumping level to pump.
- 1 1" foot valve (750756 or 750752P).
- 1 well seal, as per well casing diameter (750929 6" x 1").
- 1 1" well seal elbow (750860).
- 2 1" male adaptors (750865 or 750871).
- 8 1" stainless steel clamps (750885).
- Teflon tape.
- 1 1" valve for your discharge line.

Tools

Screwdrivers, hacksaw to cut pipe, knife to assist in pipe cutting, round file to smooth pipe ends, pipe wrench, adjustable wrench to tighten fittings, propane torch and welding material.

APPLICATION

- This pump is designed for shallow well installation for water level up to 25 feet.
- CAPACITY AT 20 PSI, express in US GPH

5'	900
10'	750
15'	640
20'	560
25'	475

FRICITION LOSS IN
PIPE NOT INCLUDED

FEATURES

- Easy to prime cast iron or stainless steel pump body
- Totally enclosed, fan cooled motor, bearing to bearing. Built for a continuous use.
- Full time connected run capacitor, to eliminate starting wear vs regular motor.
- Thermal and overload protection.
- Noryl impeller, built-in injector
- 3/4HP 115VAC, 60Hz, 7.2A
15A (*when the pump start*)

INSTALLATION STEPS

STEP 1

We recommend that you install your pump in a clean and dry location where there is adequate room for servicing at a later date. Protection from freezing temperatures and good ventilation should be considered as well, to provide the pump an environment for long life. Locating the pump as close as possible to the water source will reduce friction losses encountered in the suction pipe.

Friction losses in the suction pipe must be taken into consideration when the horizontal offset is greater than 50 feet. The suction pipes should be increased from 1" to 1 1/4". This will reduce friction losses and allow the pump to give maximum performance.

A new well should be checked to determine that it is free from sand. Sand will damage the seal and the impeller. Have your well driller clean the well before your installation.

Never run the pump dry. Damage to the seal may occur. Fill pump body and suction pipe with water before turning on the power.

VERY IMPORTANT

Please be advised that the Fluomac Electronic unit is a state of the art product and will give you years of trouble free service. However, if the unit cycles "ON and OFF", this means there is a leakage in your plumbing. For example: A toilet leak, the leakage must be repaired to maintain the system pressure.

Furthermore, if you are pumping water from a sand point or if you have indication that your well may contain sand, a sand filter must be installed in the suction of the pump.

Sand will damage the unit, due to its abrasive nature and will void warranty. For more information, we are enclosing a brochure on our Sand Filter model # 750896, which is available from any Burke Retailers or Wholesalers. In the meanwhile, if you have any questions concerning your pump, please contact us on our toll free number 1-800-361-1820 before returning the pump to the point of purchase.

The above conditions are not on warranties. The warranty covers manufacturing defects only.

THE RUN OF HORIZONTAL PIPE FROM THE TOP OF YOUR WELL INTO THE HOUSE, WHERE YOUR PUMP WILL BE LOCATED, MUST BE INSTALLED IN A TRENCH, BELOW THE FROST LEVEL OF YOUR AREA.

FOR INFORMATION

TEL: 514.337.4415

FAX: 514.337.4029

SHALLOW WELL APPLICATION

SEE DIAGRAM ON NEXT PAGE

STEP 2 Cut the desired length of poly pipe to run from the top of the well to the pumping level. Smooth the pipe cuttings with your round file. (Check that no cut-out parts are left inside of pipe. This may block pump injector or impeller).
Tape male adaptor threads with teflon tape and thread adaptor into the foot valve.
Slide 2 stainless steel clamps over one end of pipe and use torch to soften pipe. Insert the male adaptor and foot valve into this pipe end. Tighten clamps with screwdriver.
For security against leaks, we suggest to install 2 stainless steel clamps on each adaptor.

STEP 3 Insert the well seal elbow thru the opening of the seal.
Slide 2 stainless steel clamps over the free end of the previously cut pipe and soften pipe with your torch. Attach pipe to the well seal elbow (end protruding at bottom of well seal). Tighten clamps with screwdriver when cool.

STEP 4 Install the well seal and piping assembly into your well casing. Tight down the well seal bolts using your adjustable wrench.

To facilitate servicing at a later date, you may use a pitless adaptor and a sealed well cap instead of an elbow and a well seal as describe in steps 3 and 4.

STEP 5 Install your pump in the house, on a sound foundation, as close as possible to the basement wall. Thread an adaptor into inlet using teflon tape. Do not over tighten.

STEP 6 Cut the desired length of pipe from pump location to the well seal and connect both ends using the previous way, with stainless steel clamps and torch. Before connecting your pipe to the pump, fill the suction line with water.
Do not fill in your trench to the house until you have checked for any leaks in your connections or trouble in your water system.

STEP 7
for sand
or well
points
Sand or well points are limited to areas where water bearing sand or gravel lies below the surface, and where there are no boulders or rocks to interfere with the driving into the ground of the point.
The amount of water any "one" well point will supply is usually rather limited. Sometimes, it is necessary to use more than one point to increase the supply of water, entering to the pump's suction.

THE IMPORTANT INSTALLATION STEP IN USING WELL POINTS IS THAT A CHECK VALVE MUST BE USED IN THE SUCTION PIPE LEADING TO THE SUCTION INLET, AS CLOSE TO THE PUMP AS POSSIBLE, TO KEEP SUCTION LINE AND PUMP WELL PRIMED.

SHALLOW WELL APPLICATION

STEP 5 Install your pump and thread an adaptor into inlet.

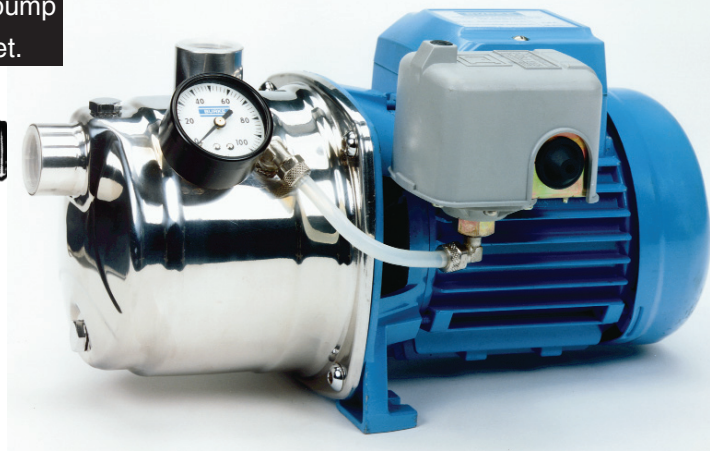

STEP 6 Cut poly pipe and connect both ends.

STEP 3 Insert well seal elbow thru the seal and attach to pipe.

STEP 4 Install well seal and piping into well casing.

STEP 2 Cut poly pipe and install the foot valve.

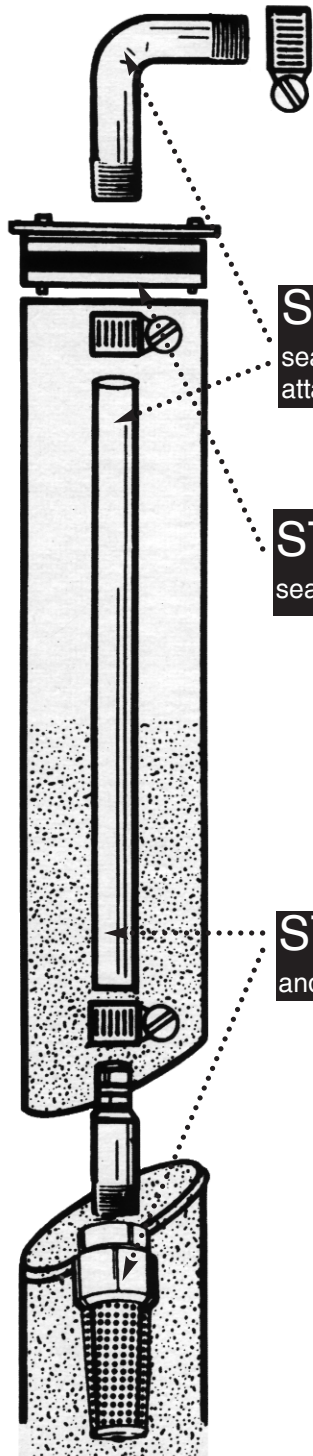

Well point optional installation

STEP 7 You may install one or more sand points to increase the supply of water.

Check valve, close to pump.

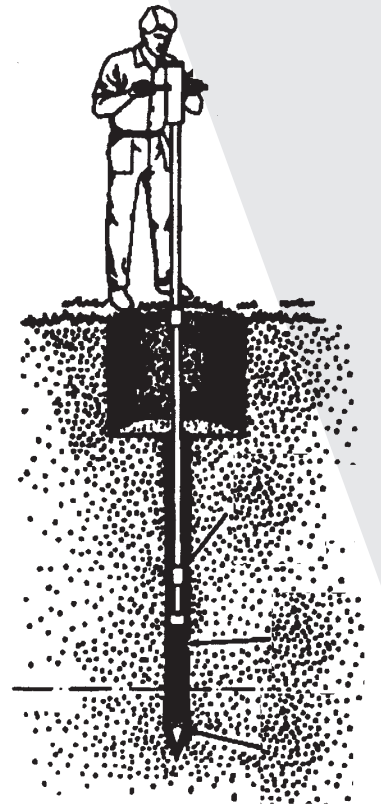
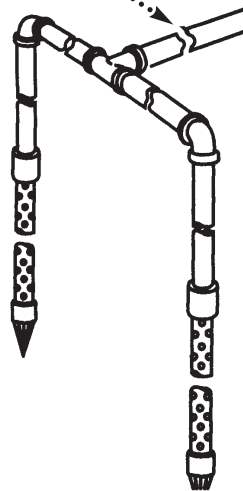

PRIMING INSTRUCTIONS

PLEASE, FOLLOW THESE STEPS TO EASILY PRIME YOUR PUMP.

STEP 8 Connect your discharge line, using a ball valve, as illustrated. (photo 1)

STEP 9 Fill the suction line with water and connect it to suction inlet (Photo 1).

STEP 10 Remove the plug of the priming pipe and fill the pump body with water (Photo 1).

STEP 11 Screw the plug to the priming pipe using teflon tape.(photo 2)

STEP 12

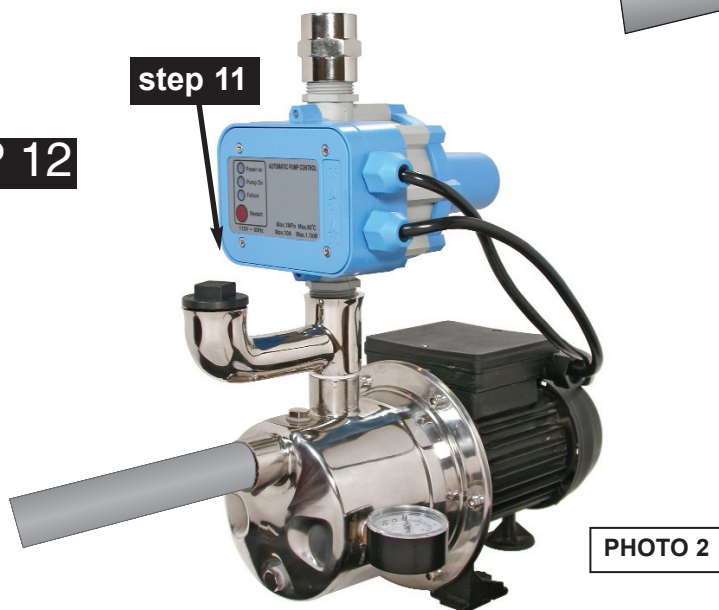
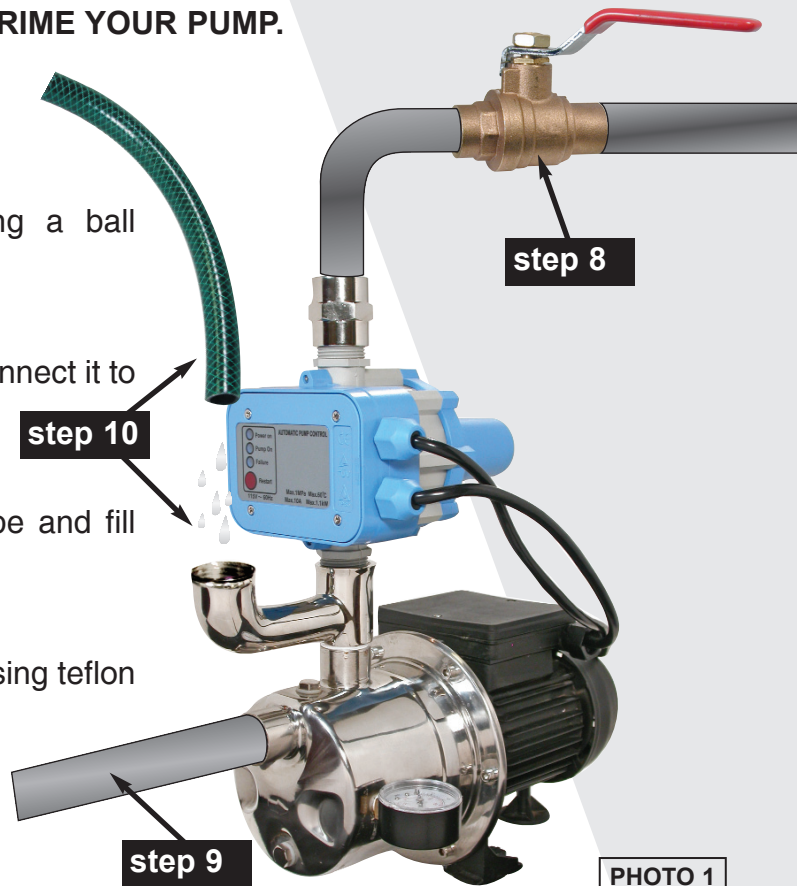

Connect the pump. The pump should delivered water to the plumbing line within 30 seconds. If not, unplug the pump and repeat from step 10. In accordance with the length of your suction line, you may have to repeat these steps a few times.

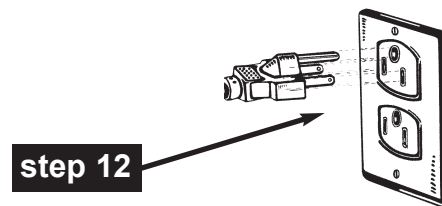

NOTE: After installation, if the pump is cycling “on-off” and/or comes on when you are not visibly using water, the pump is not defective. It means you have a leak on the discharge side of the pump. The leak must be localised and needs to be repaired. If you need assistance to determine same, please call 1-800.361.1820. The pump is warranted by the manufacturer and you must call us to determine procedures. The pump cannot be returned to the point of purchase without our prior consent.

BOOSTER PUMP APPLICATION

NEVER RUN THE PUMP DRY

STEP 1 To use this pump for pressure boosting, read carefully the instructions for shallow well application, then connect the pump to your water supply as per the pictures on right.

STEP 2 Use appropriate union (not shown) to connect pipes for an easy service at a later date .

STEP 3 If your incoming pressure is higher than 20 PSI, install a pressure reducer (not shown) between the ball valve #1 and the pump, setted to 20 psi. This will prevent an excess of pressure on the house distribution piping.

STEP 4 Install a pressure gauge as per the pictures on the right, to monitor the pressure in piping.

STEP 5 Set the ball valves as per “to operate the pump” picture. Open the nearest faucet and connect the pump to an electrical outlet.

STEP 6 When all the air will be remove from the piping, close the faucet. The pump will stop after 7 to 10 seconds. Then, it will turn on when a faucet is open.

WARNING
In a booster pump application the incoming pressure must never be higher than 20 PSI.

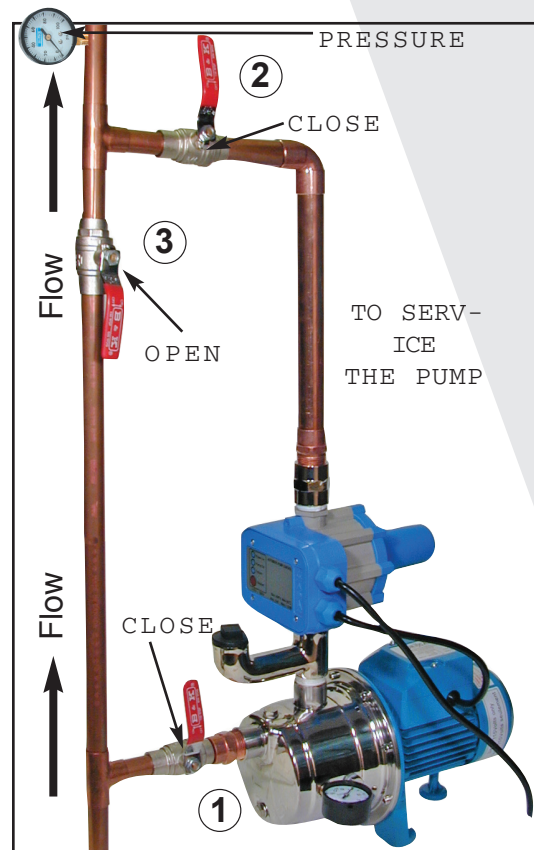
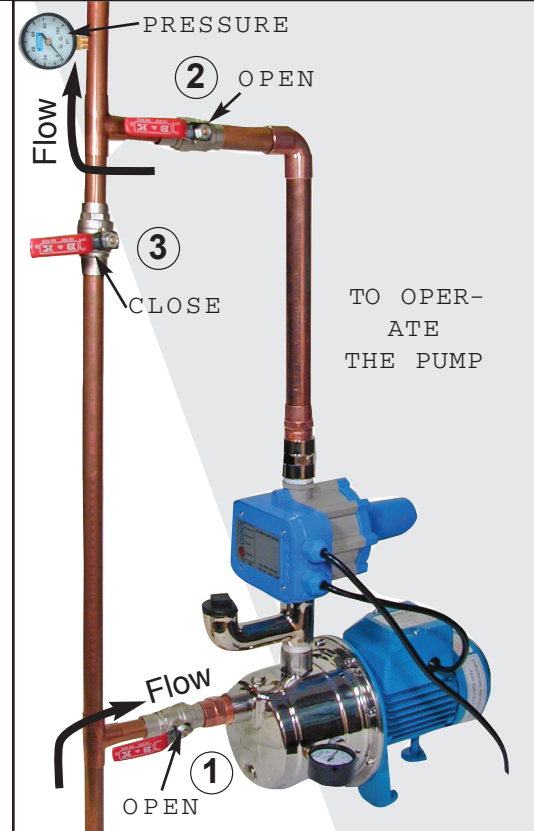

REPAIR PARTS

Model 506532SS

REF	ITEMS	DESCRIPTION	REF	ITEMS	DESCRIPTION
1	510000	Pump body	11	510010	Seal plate
2	510001	Priming / drainage plugs (2)	12	510011	Water slinger
3	750769	Pressure gauge	13	510012	Motor
4	510003	Pump body screw (6)	14	510013	Capacitor
5	510004	Venturi O - Ring	15	510014	Junction box cover
6	510005	Venturi / Diffuser	16	510015	Motor foot
7	510006	Impeller	42	506375	SS Priming tube
8	510007	Washer	43	506377	Priming plug & washer
9	510008	Mechanical seal	44	506376	Discharge Fitting
10	510009	Seal plate O-Ring	45	600600GP	Fluomac

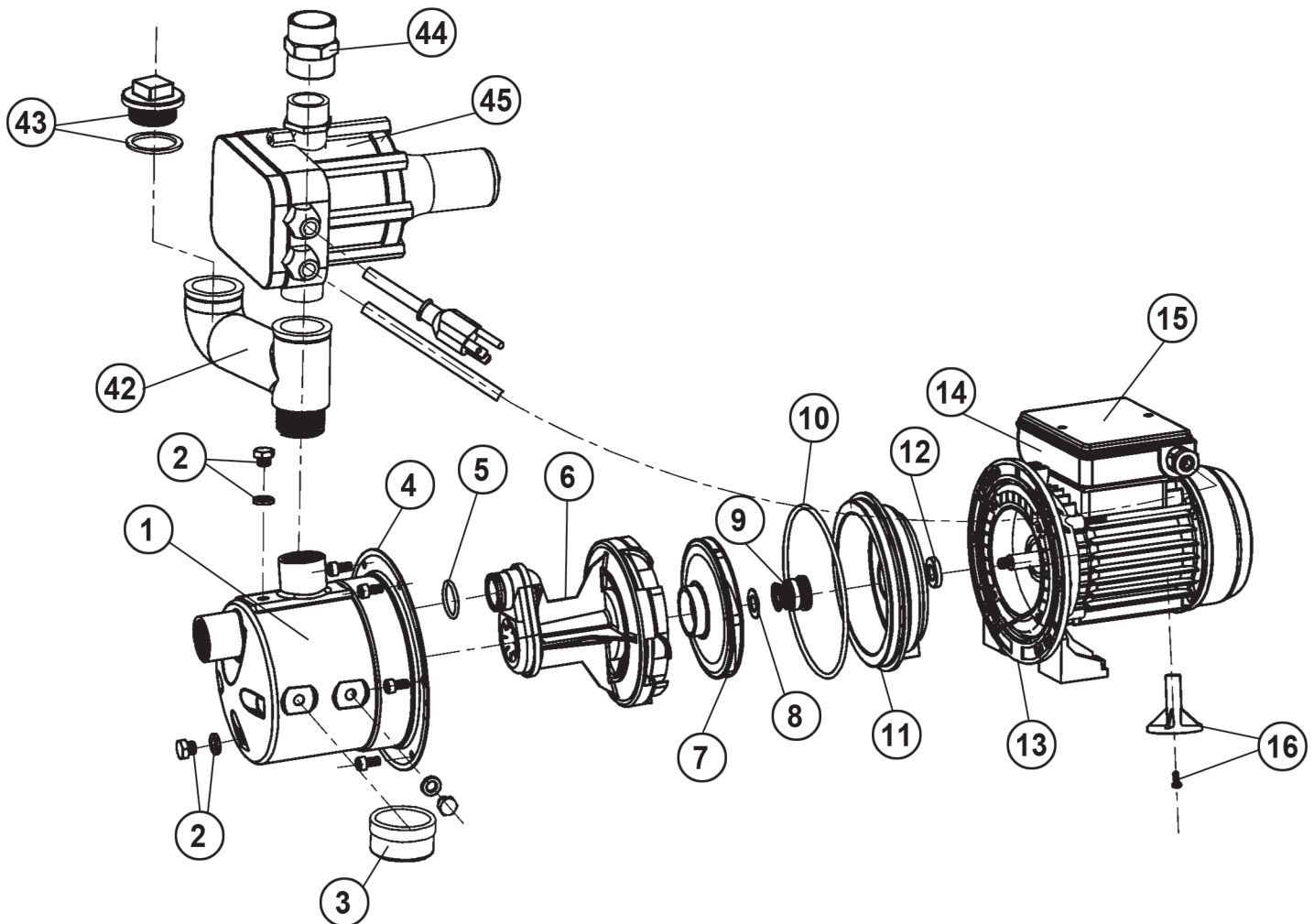

506532SS VERSION W 2009

Repair parts may be ordered from your authorized point of sale or from
BUR-CAM PUMPS

TROUBLE SHOOTING GUIDE CHECKLIST

NEVER MAKE ADJUSTMENTS TO ANY ELECTRICAL APPLIANCE OR PRODUCT WITH THE POWER CONNECTED. DON'T JUST UNSCREW THE FUSE OR TRIP THE BREAKER, REMOVE THE POWER FROM THE RECEPTACLE.

TROUBLE	PROBABLE CAUSE	ACTION
Motor does not run.	Blown fuse Tripped breaker Defective motor	Replace Reset Replace
Motor runs but no water is delivered.	Pump not primed Leaky suction line Foot valve plugged Ejector nozzle clogged Water level below foot valve Suction lift to great Improper voltage	Prime with clean water Check pipe and pipe connections Clean Clean Check foot valve level Water level lower than lift capacity Check voltage
Pump does not deliver to full capacity.	Water level below foot valve Ejector nozzle clogged Excessive friction in pipe Improper voltage	Check foot valve level Clean Too small or dirty pipe Check voltage
Pump does not shut off.	Leaky discharge line Motor not up to normal speed Improper setting of pressure switch Ejector nozzle clogged	Check all pipes for leak Check power cable and voltage Reset or replace Clean
Pump starts and stop too often.	Leaky foot valve Leaky suction line Foot valve do not close properly Pressure switch out of adjustment Leaky discharge line (toilet etc.)	Replace Check pipe and pipe connections Clean or replace Adjust on/off setting Check all pipes for leak
Air spurts from faucets.	Leaky suction line Gaz in water Airlogged tank (galvanized)	Check pipe and pipe connections Check and consult factory Replace air volume control

TO THE END CONSUMER

If you have any problems with the product, before advising the store, where you've purchased the pump, please contact us at 514 337-4415 , and ask for our sales department, and they will be pleased to help you with any questions you might have, concerning your installation.

FLUOMAC

TROUBLE SHOOTING GUIDE CHECKLIST

NEVER MAKE ADJUSTMENTS TO ANY ELECTRICAL APPLIANCE OR PRODUCT WITH THE POWER CONNECTED. DON'T JUST UNSCREW THE FUSE OR TRIP THE BREAKER, REMOVE THE POWER FROM THE RECEPTACLE.

TROUBLE	PROBABLE CAUSE	ACTION
Power supply is on, no light are lit.	Unit may be defective	Test electrical terminals with voltmeter. If there is no power, replace the unit
Power supply is on, pump on light is off, failure light is on.	<p>Lost of prime due to a low water level condition</p> <p>Water pipe obstructed from water supply to pump</p> <p>Power cut-off by thermal protector</p> <p>Pump cannot reach proper minimum operational pressure</p>	<p>Wait for water level resume and press reset button</p> <p>Clean obstruction and press reset button</p> <p>Wait 10 minutes and press reset button</p> <p>Clogged pump nozzle and/or venturi, clean and press reset button</p>
Power supply is on, pump on light is on, failure light is off, and pump short cycles On and Off.	Loss of pressure due to leak in the piping	<p>Make sure all taps are closed and all toilet valves are functioning</p> <p>If leak not found, install a back valve after the Fluomac. If cycling stops, leak is at the supply line. If cycling occurs, leak is at suction line. Foot valve may be defective or clogged. Replace.</p>
Power supply is on, pump on light is on, failure light is off, tap is open and no flow. Pump is off.	The water column to the highest tap exceed 50 feet	<p>Pressure of water column is higher the cut-in pressure (26PSI).</p> <p>Re-install the unit at a higher level</p>

TO THE END CONSUMER

If you have any problems with the product, before advising the store, where you've purchased the pump, please contact us at 514 337-4415 , and ask for our sales department, and they will be pleased to help you with any questions you might have, concerning your installation.